

探索科學

# 科學咁樣教

圖片庫

樣章

培進·教圖

知你所需，應你所求

# 全方位 圖片庫

按圖片類別設定主分類及子分類，方便篩選內容

提供關鍵字搜索，讓老師更有效搜尋圖片，省卻備課或出題時間



大量圖片  
供老師使用



## AI 教學助理

另備 AI 教學助理，老師可利用 **圖像生成** 功能，創建更多圖片



# 目錄

<b>1 範疇一：生命與環境</b>	<b>P. 1</b>
<ul style="list-style-type: none"><li>• 人體健康</li><li>• 生物的特性</li><li>• 生命的延續</li><li>• 生物與自然環境的相互關係</li><li>• 生態系統</li><li>• 顯微鏡下的世界</li></ul>	
<b>2 範疇二：地球與太空</b>	<b>P. 19</b>
<ul style="list-style-type: none"><li>• 地球的特徵和資源</li><li>• 氣候與季節</li><li>• 宇宙中的太陽系</li></ul>	
<b>3 範疇三：物質、能量和變化</b>	<b>P. 29</b>
<ul style="list-style-type: none"><li>• 物質的特性和變化</li><li>• 能量的不同形式和傳遞</li><li>• 力和運動</li></ul>	
<b>4 範疇四：科學、科技、工程與社會</b>	<b>P. 39</b>
<ul style="list-style-type: none"><li>• 科學過程和科學精神</li><li>• 航天與創新科技</li><li>• 工程與設計</li></ul>	



# 範疇一： 生命與環境

## 人體健康

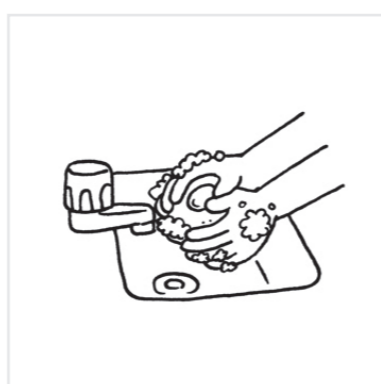
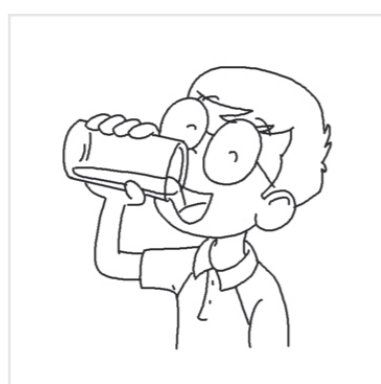
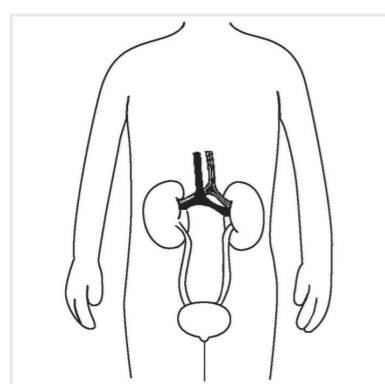
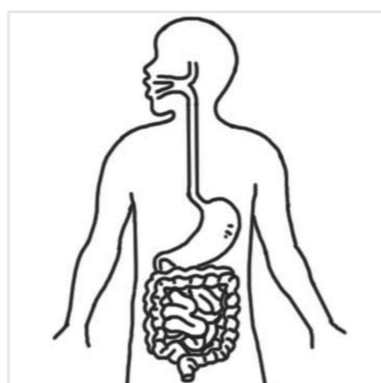
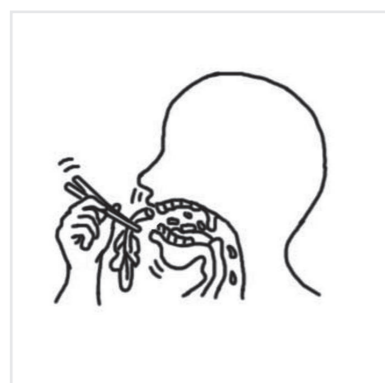
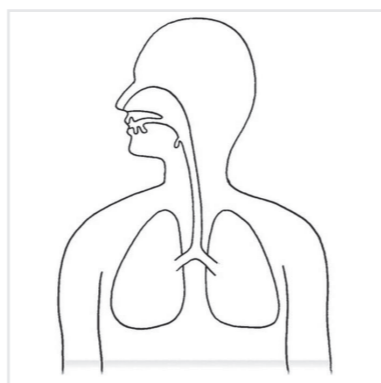
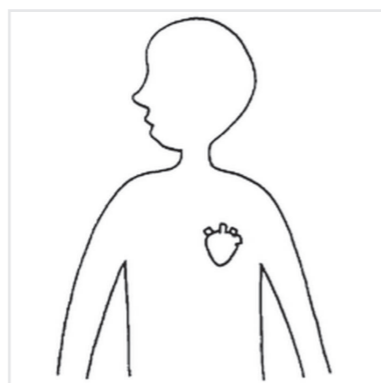
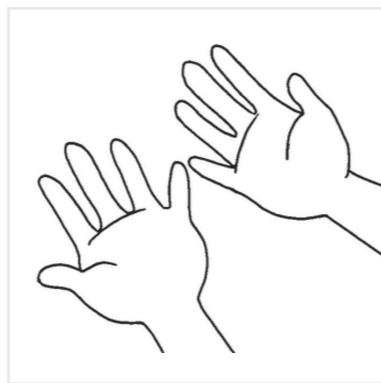
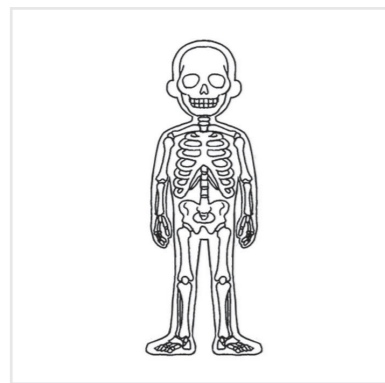

## 人體健康

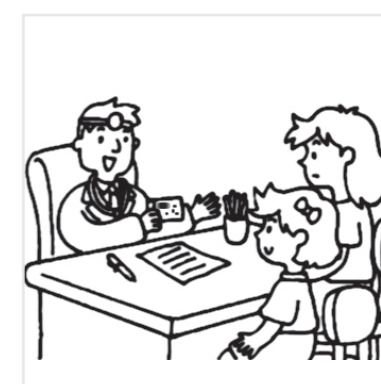
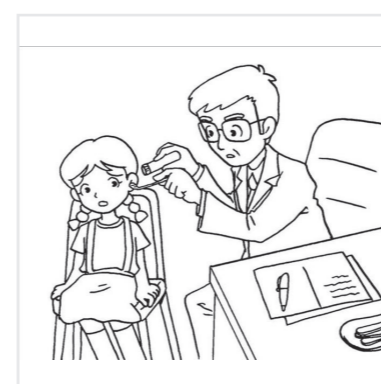
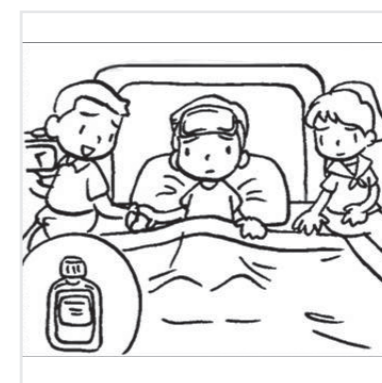
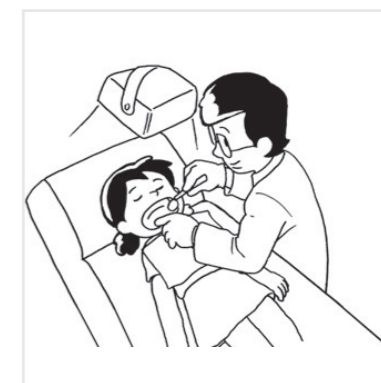
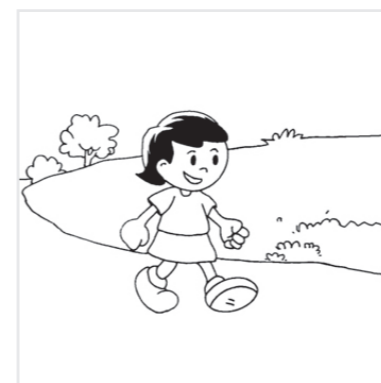
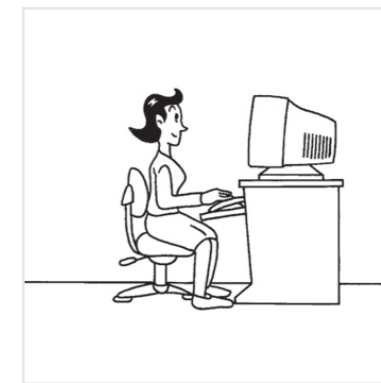



# 範疇一： 生命與環境

## 人體健康

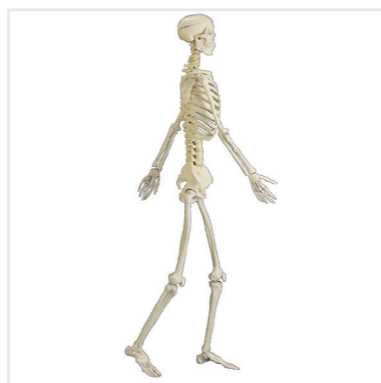
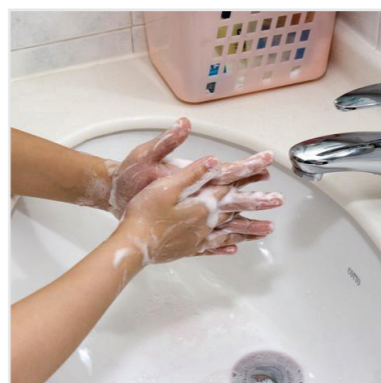
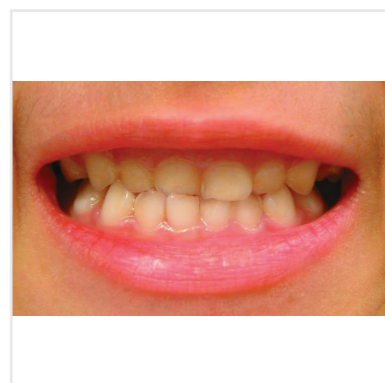
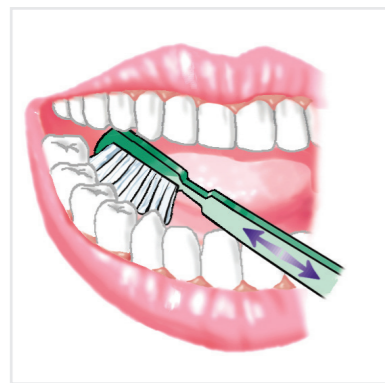

## 生物的特性

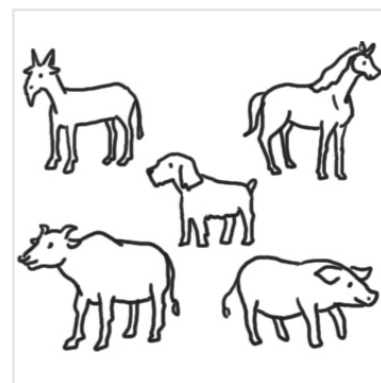
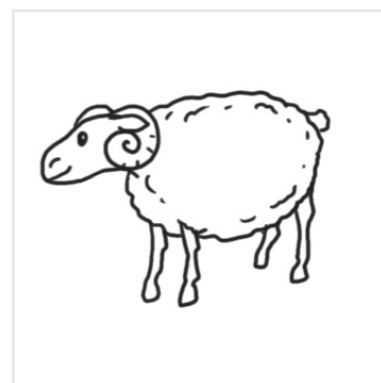
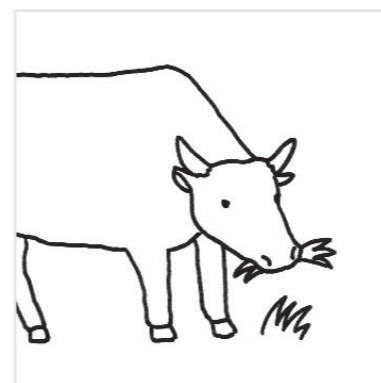
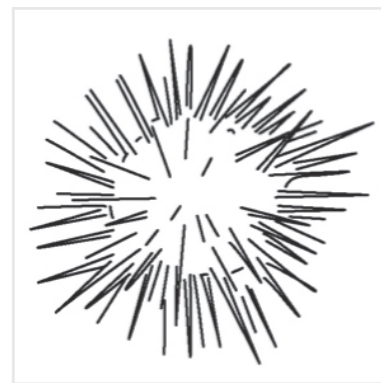
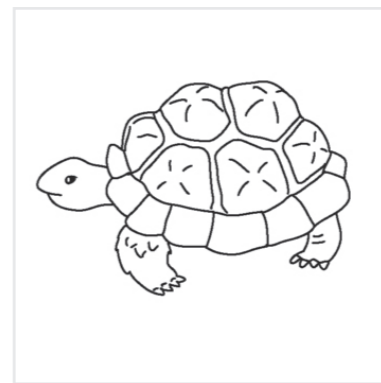



# 範疇一： 生命與環境

## 生物的特性

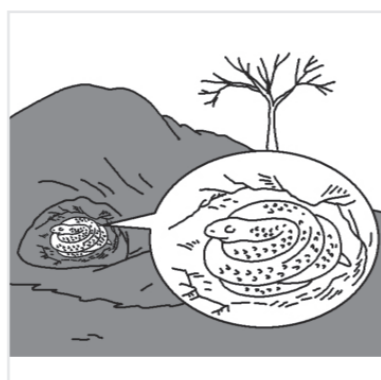
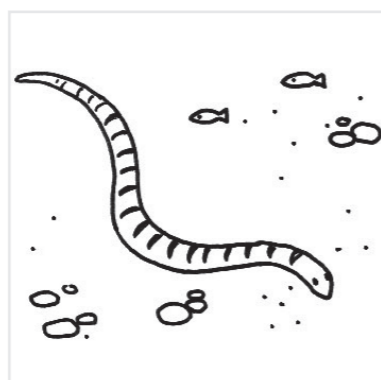
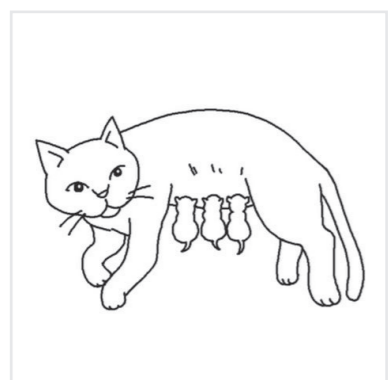
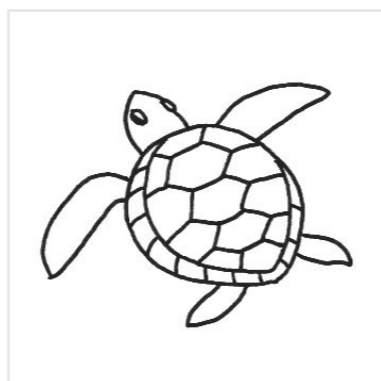
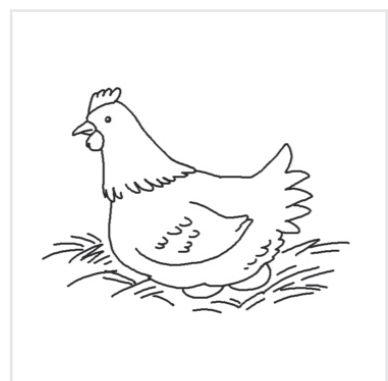
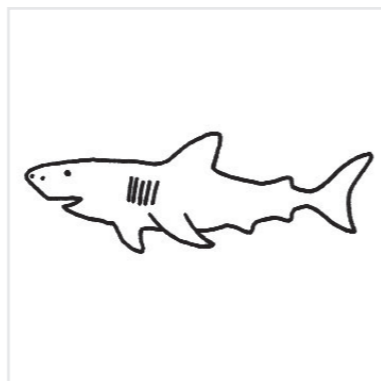

## 生物的特性

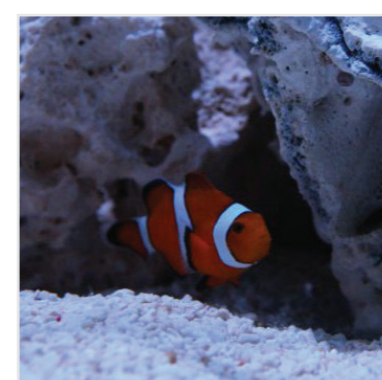
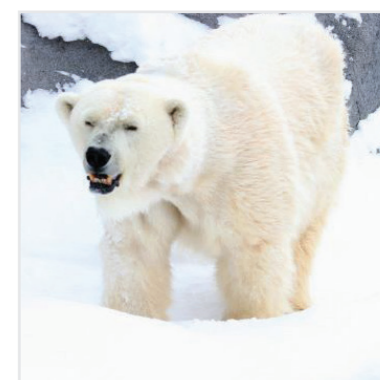
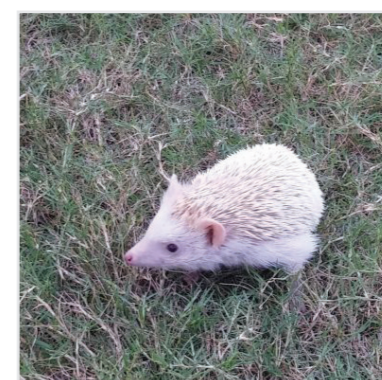
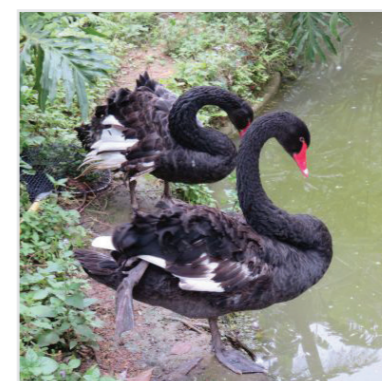
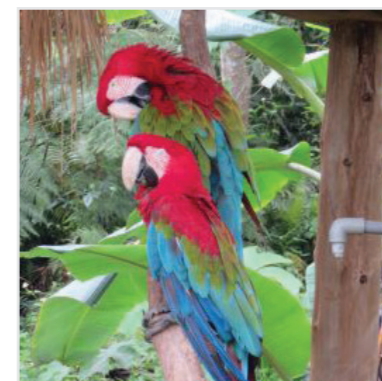
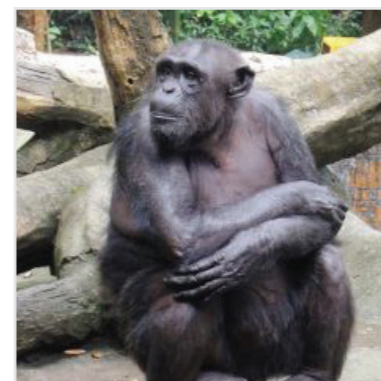



# 範疇一： 生命與環境

## 生命的延續

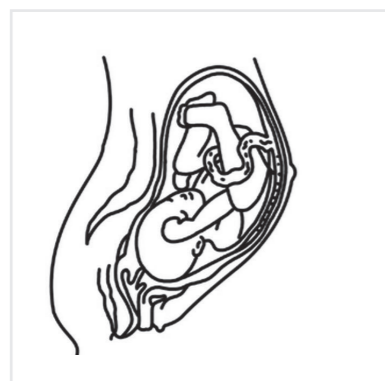
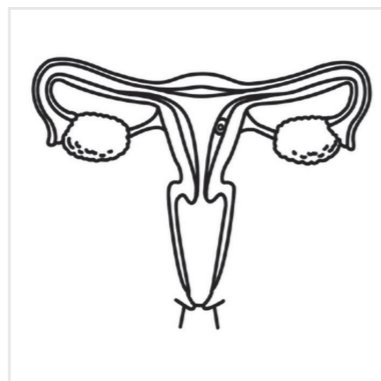
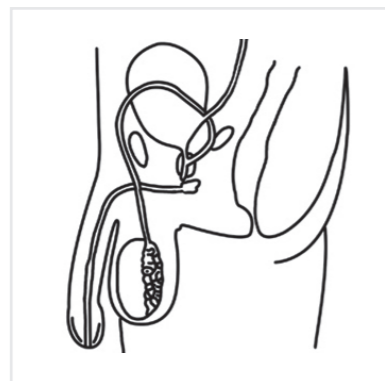

## 生命的延續

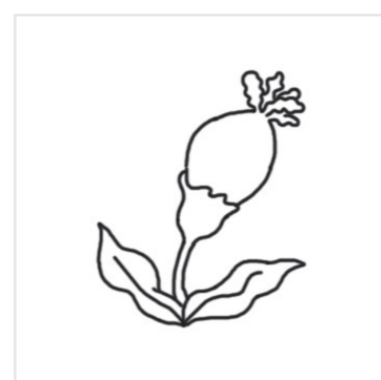
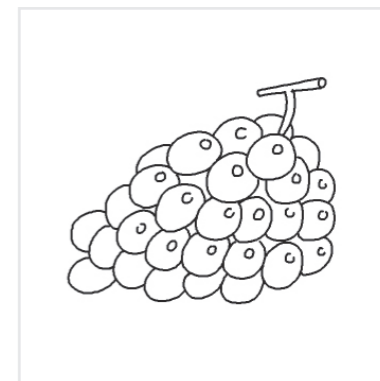



# 範疇一： 生命與環境

## 生命的延續

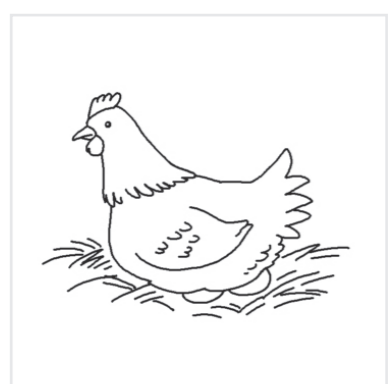
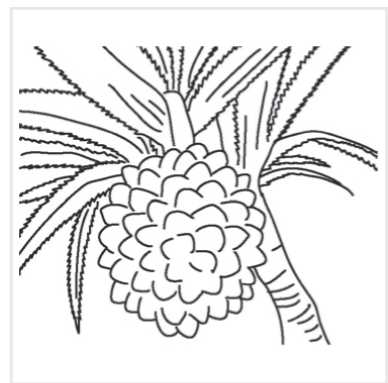

## 生命的延續

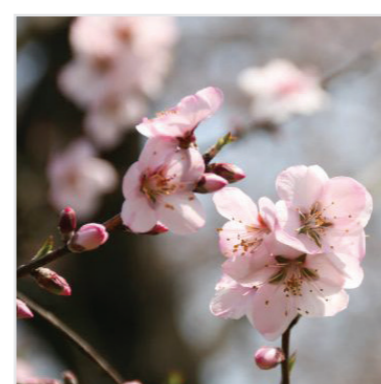
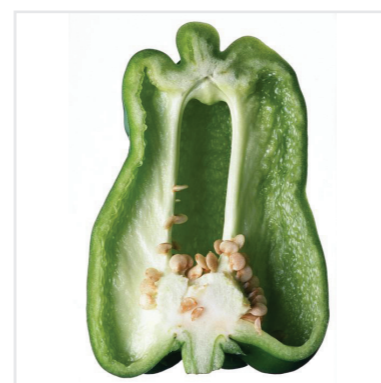
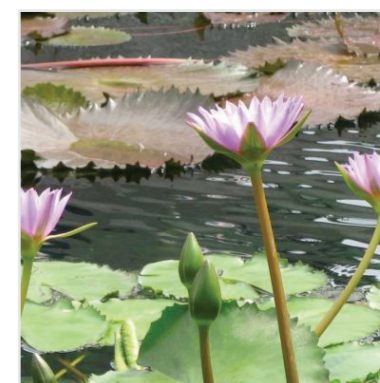
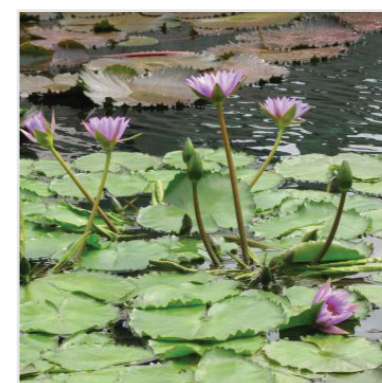
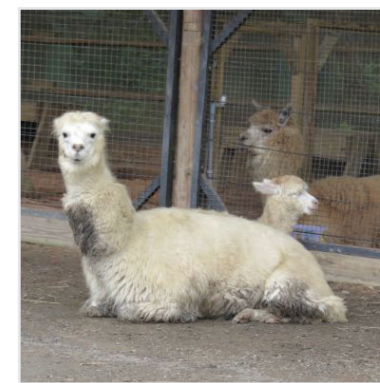



# 範疇一： 生命與環境

## 生物與自然環境的相互關係

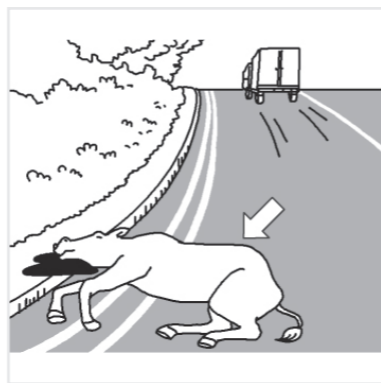
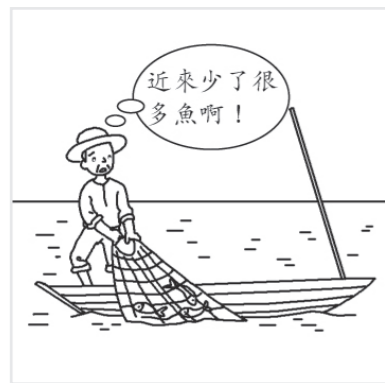

## 生物與自然環境的相互關係

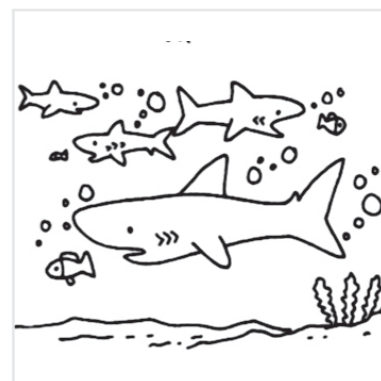
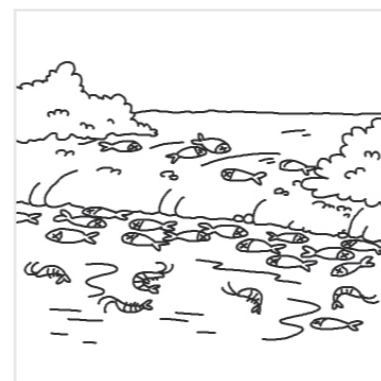
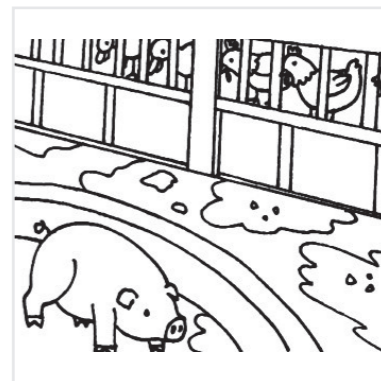
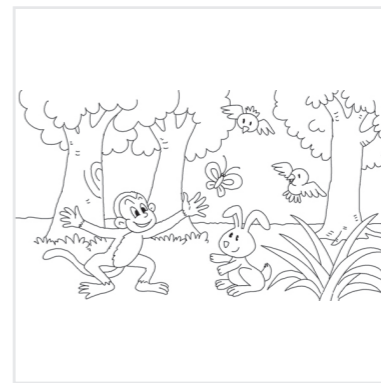





# 範疇一： 生命與環境

## 生物與自然環境的相互關係

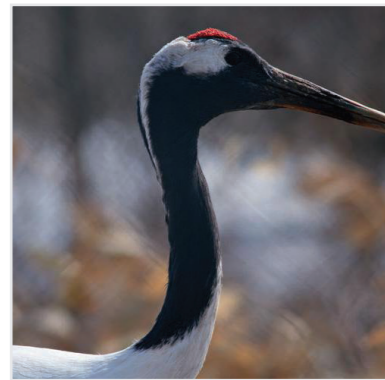
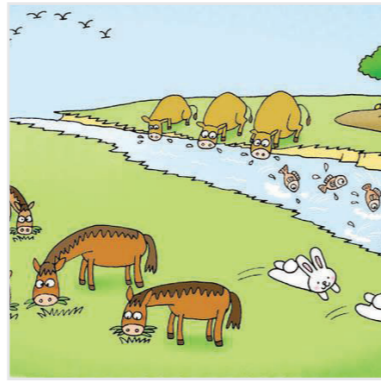

## 生態系統

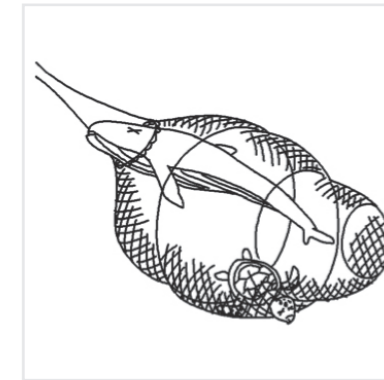
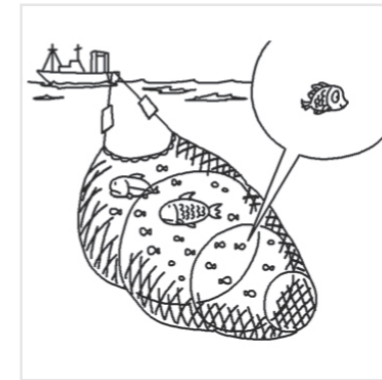



# 範疇一： 生命與環境

## 生態系統



## 生態系統

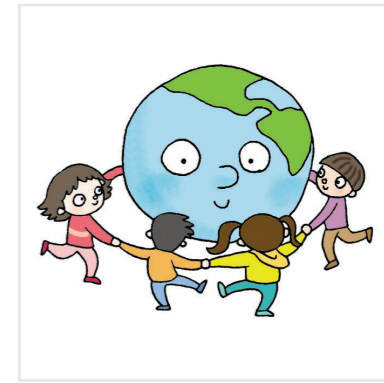
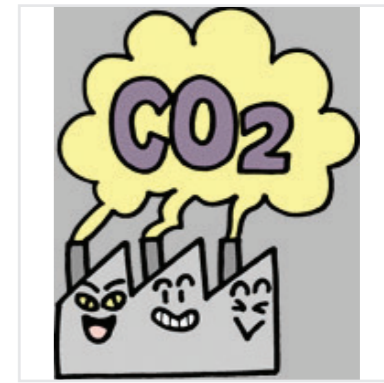
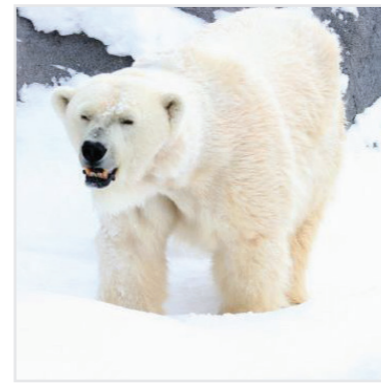



# 範疇一： 生命與環境

## 生態系統

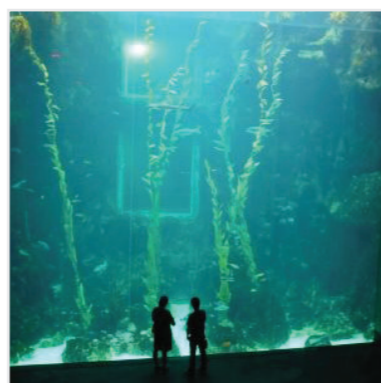
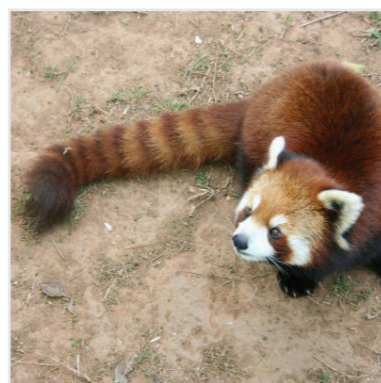
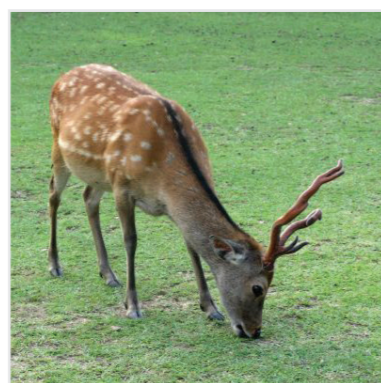
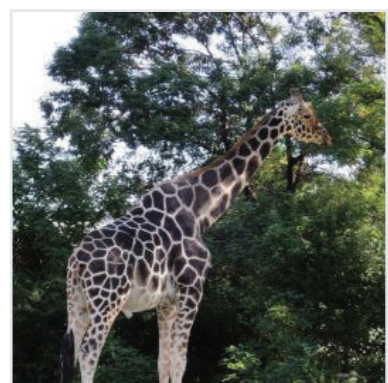
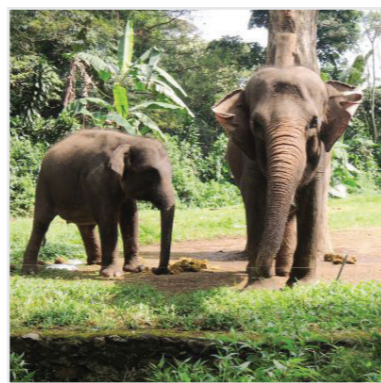

## 顯微鏡下的世界

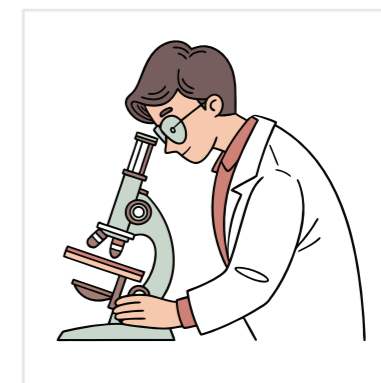
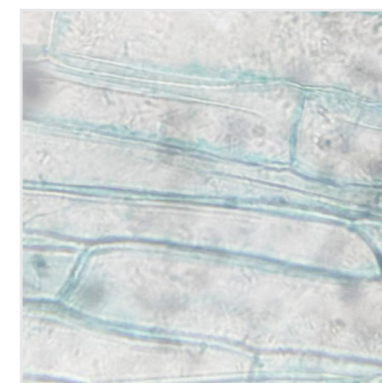
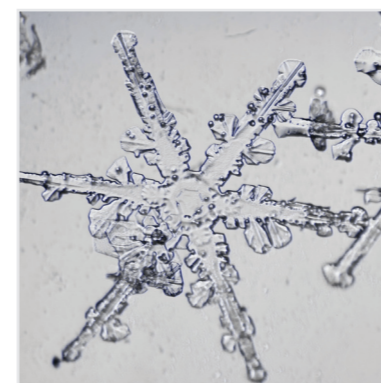
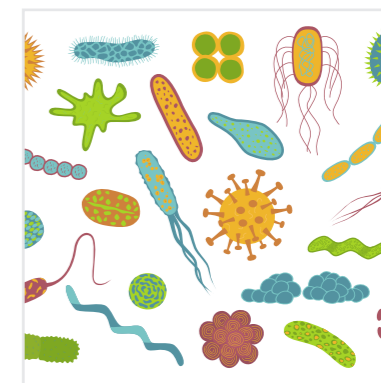
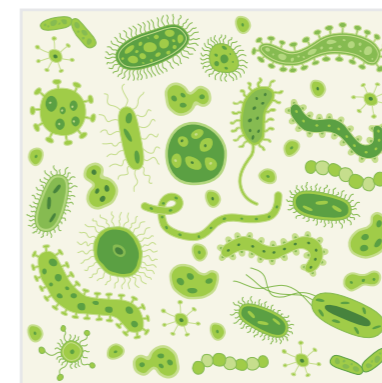
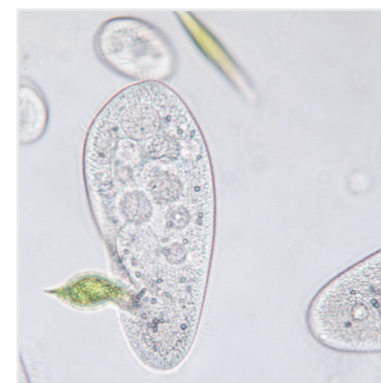
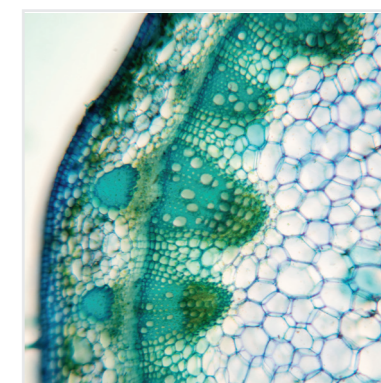
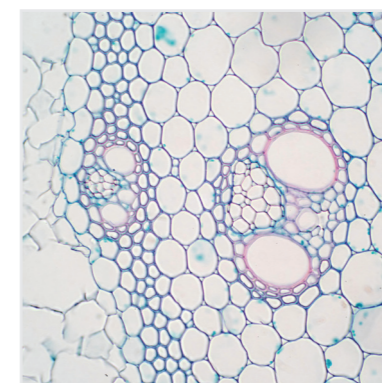
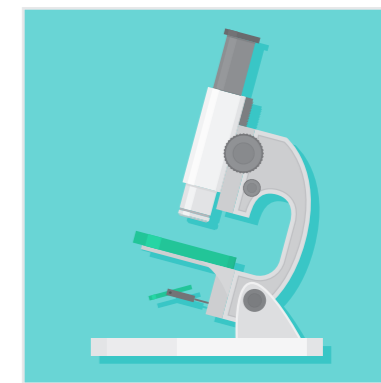



# 範疇二： 地球與太空

## 地球的特徵和資源

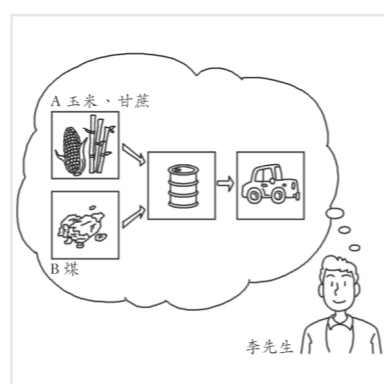
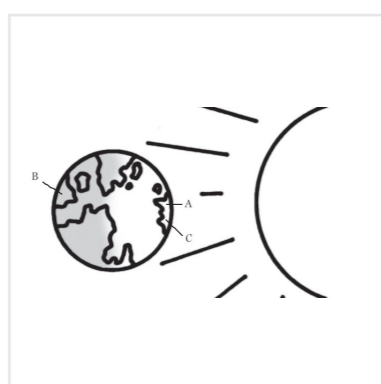
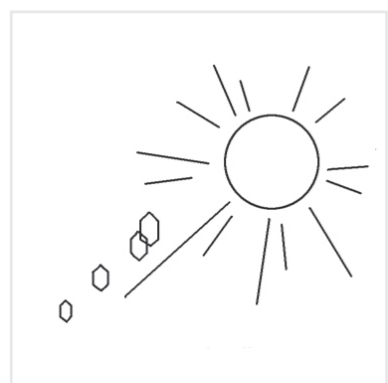
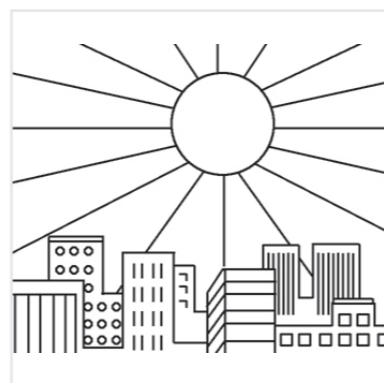
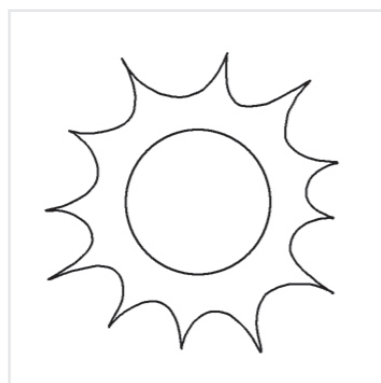
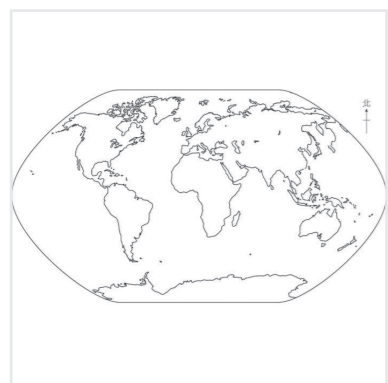
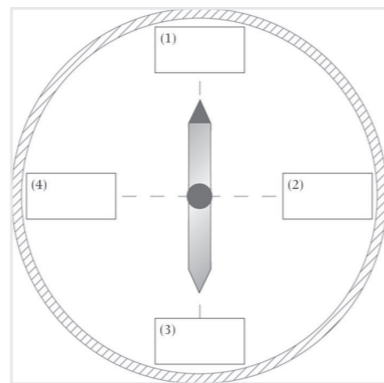
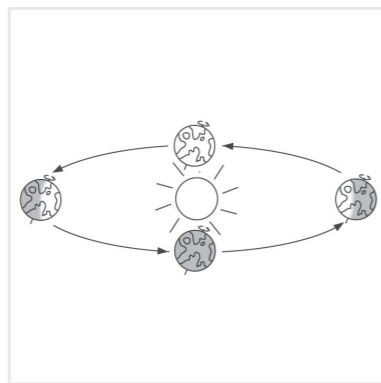

## 地球的特徵和資源

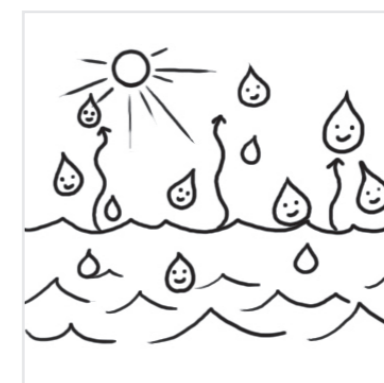
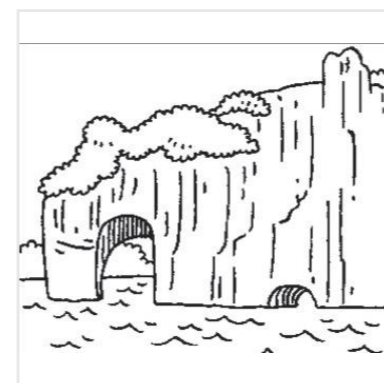
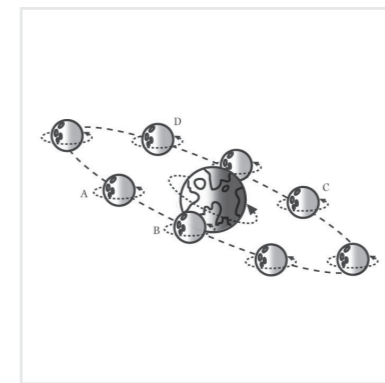
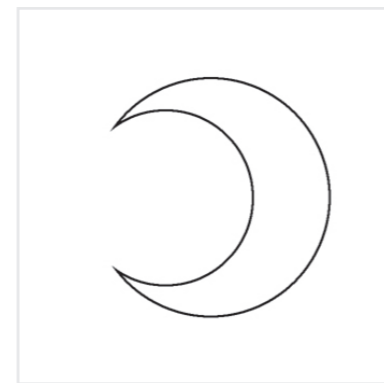



# 範疇二： 地球與太空

## 地球的特徵和資源

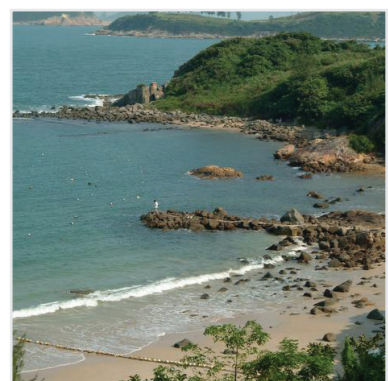
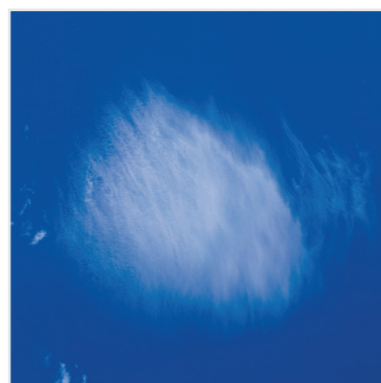
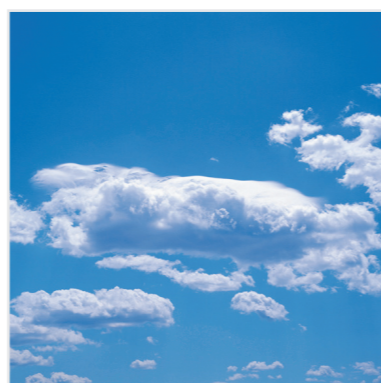
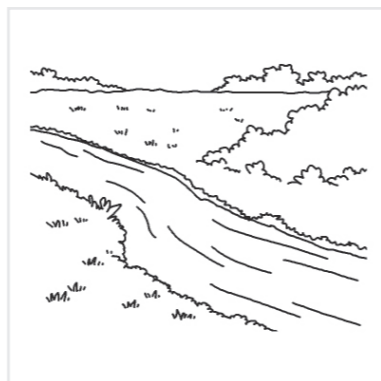

## 氣候與季節

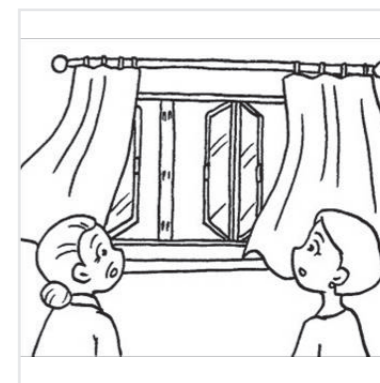
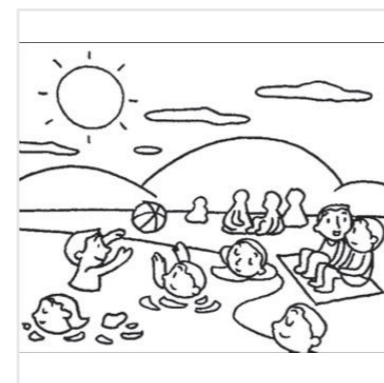



# 範疇二： 地球與太空

## 氣候與季節

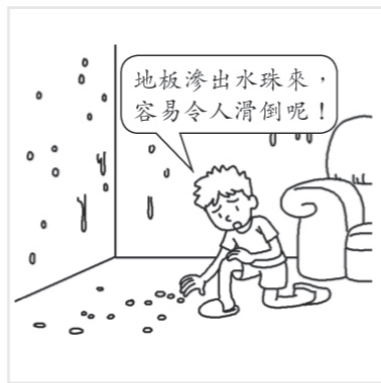
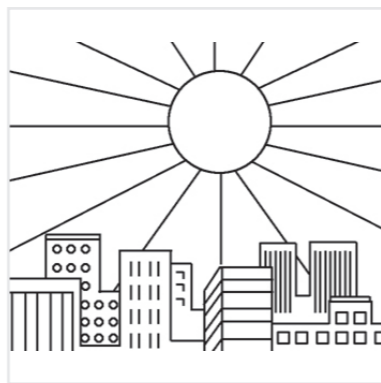
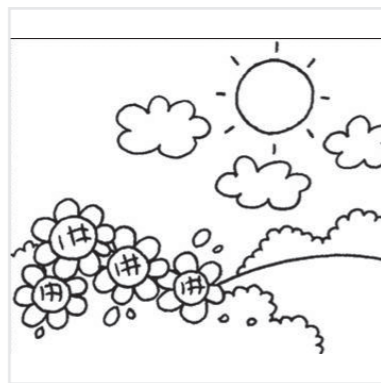

## 氣候與季節





# 範疇二： 地球與太空

## 氣候與季節

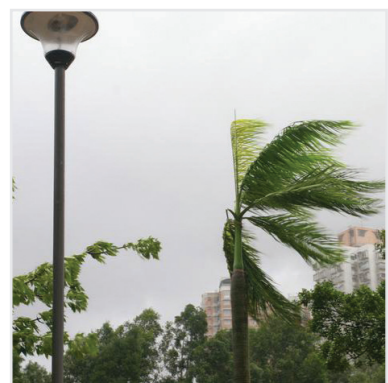
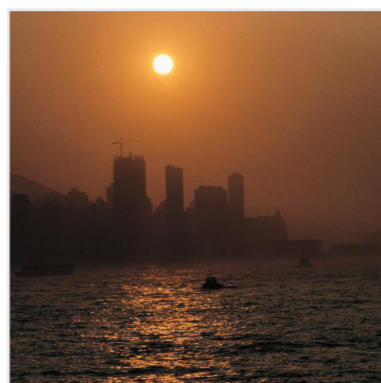
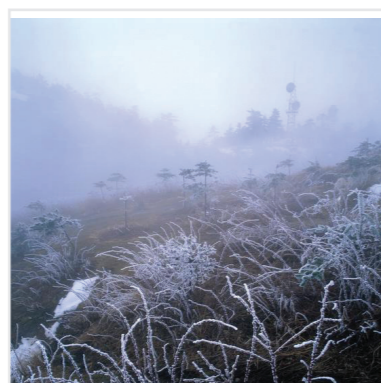
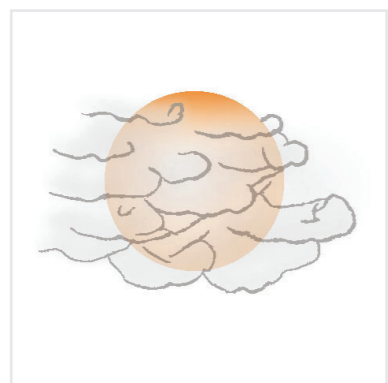
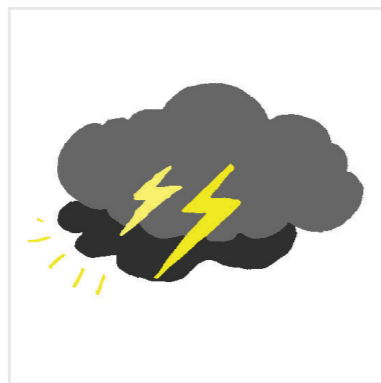

## 宇宙中的太陽系

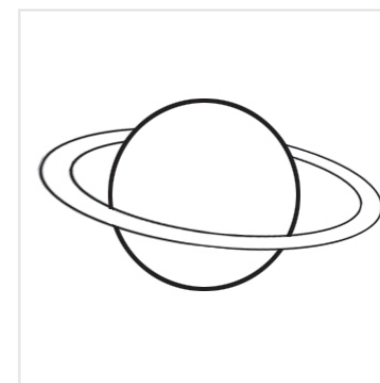
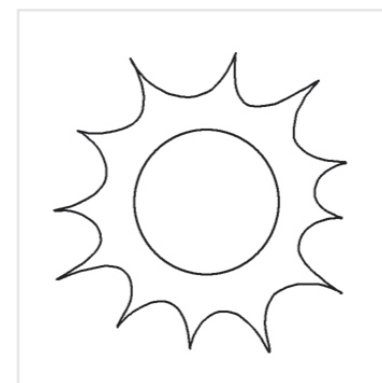
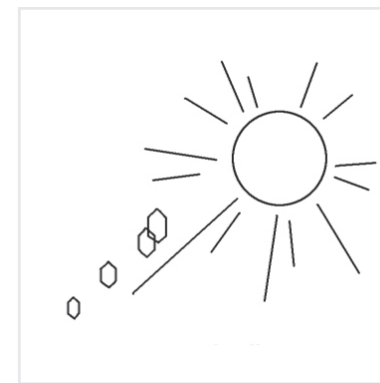
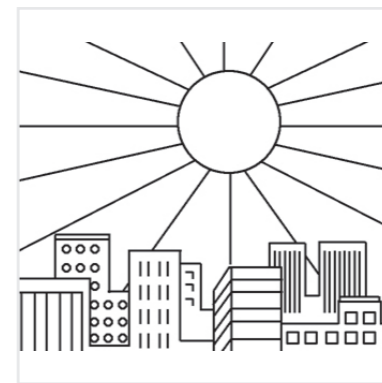
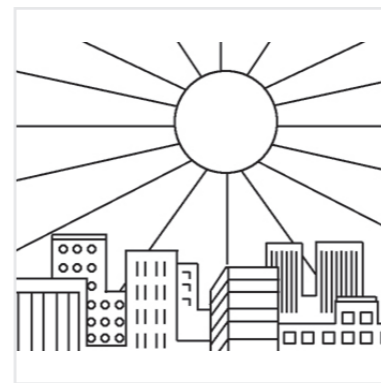



# 範疇二： 地球與太空

## 宇宙中的太陽系

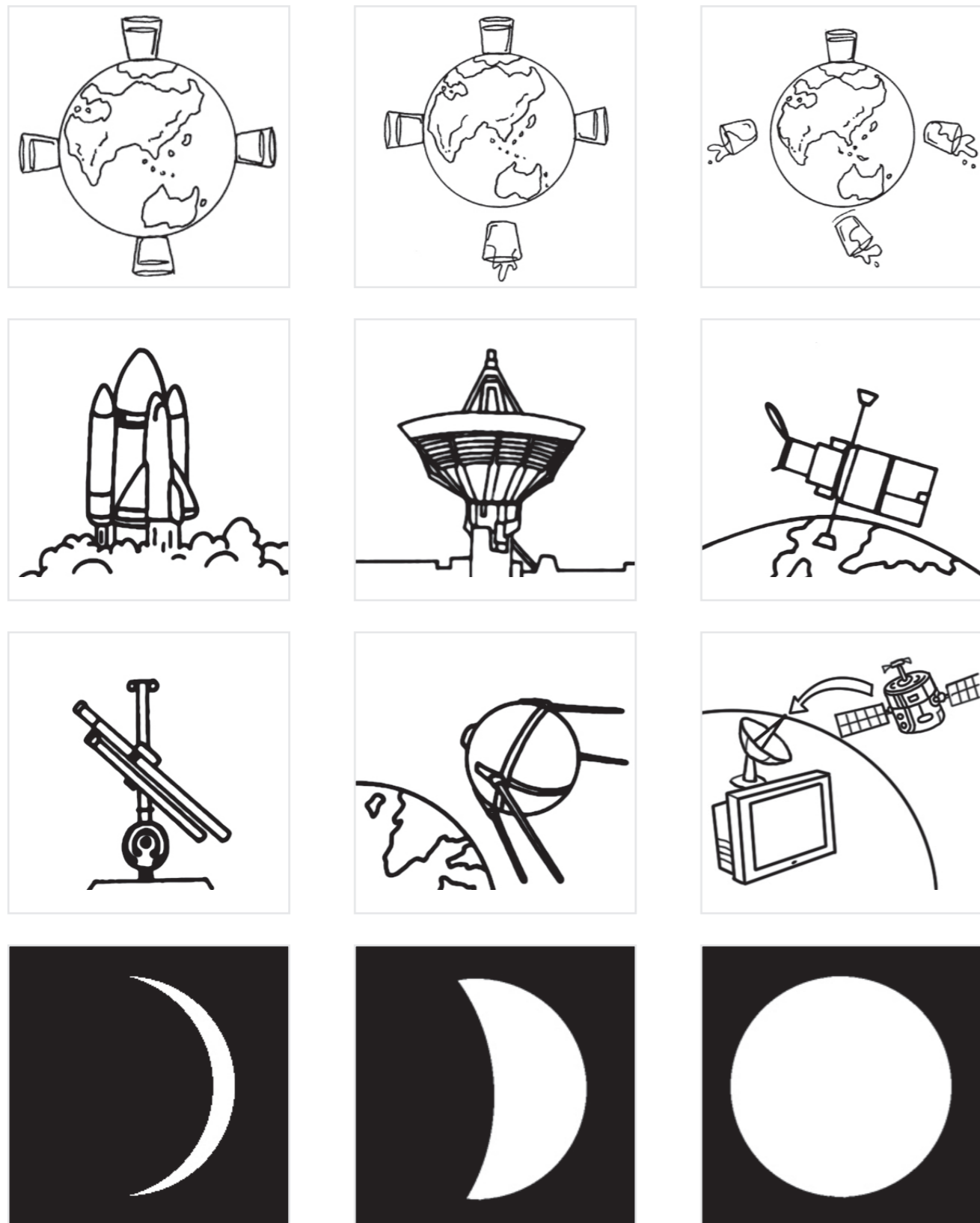

## 宇宙中的太陽系

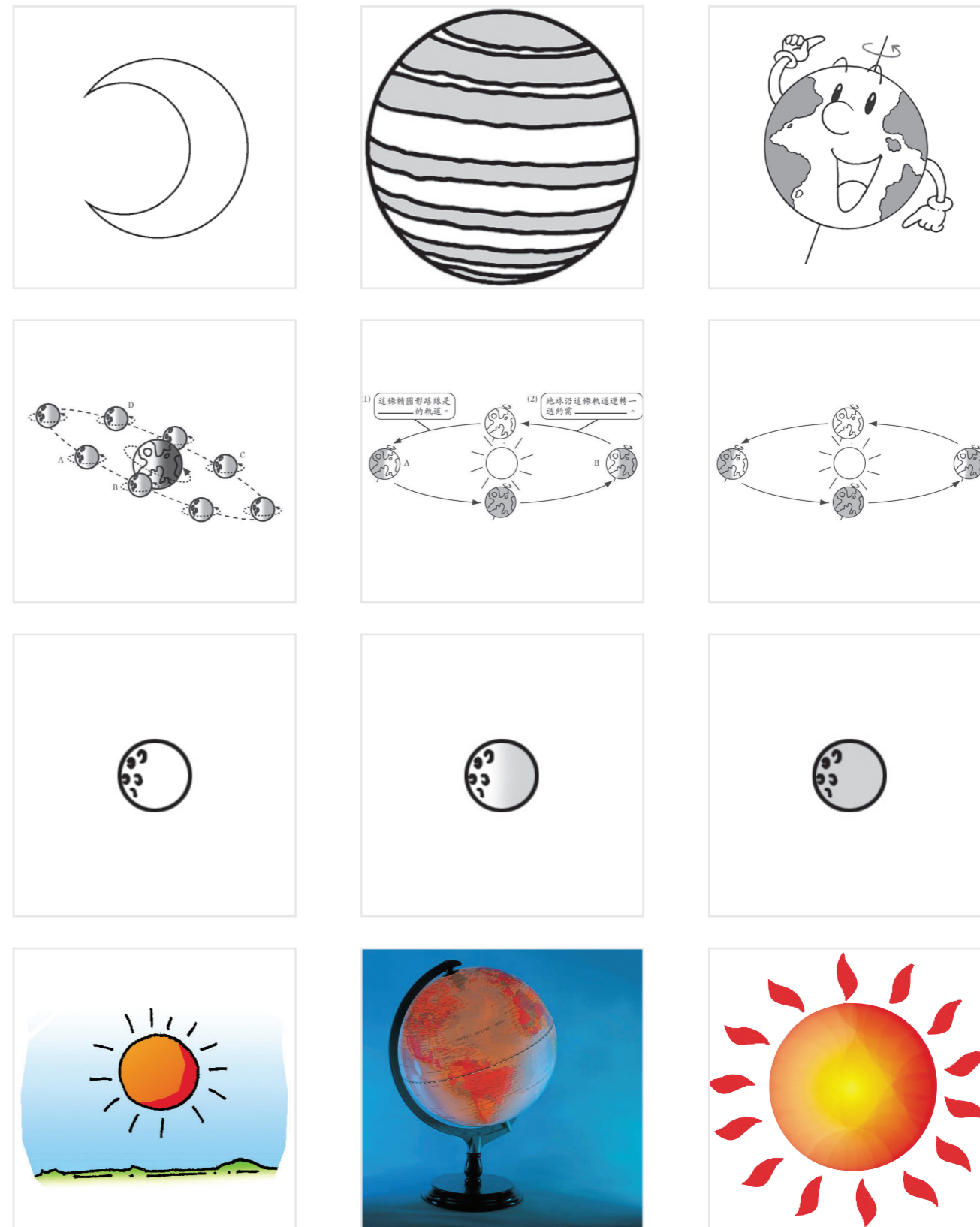





# 範疇三： 物質、能量和變化

## 物質的特性和變化

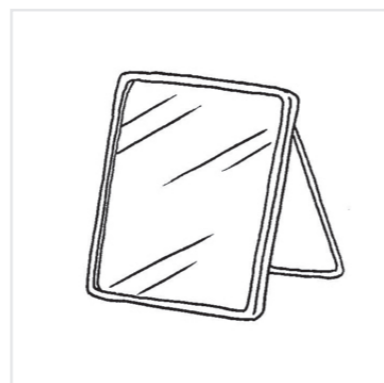
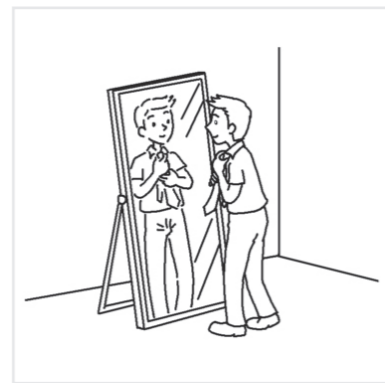
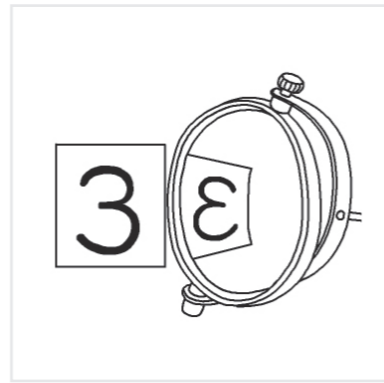
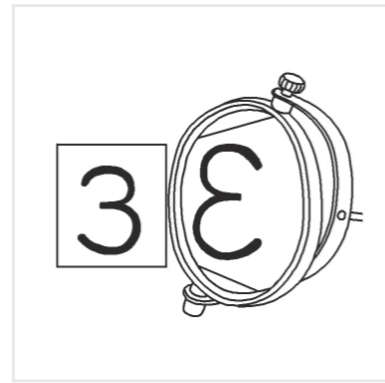
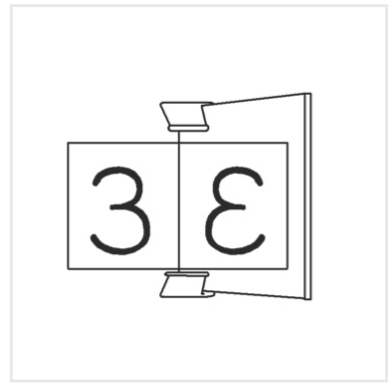
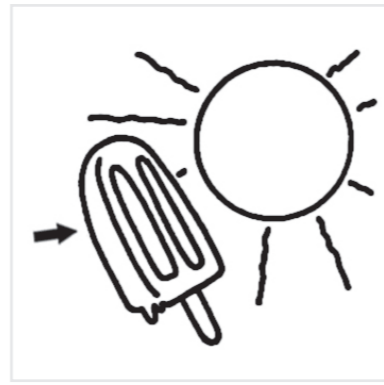
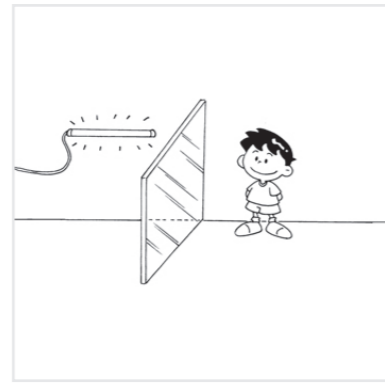
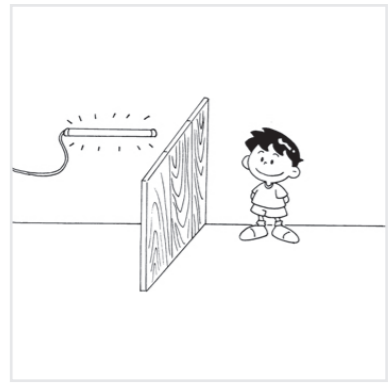

## 物質的特性和變化

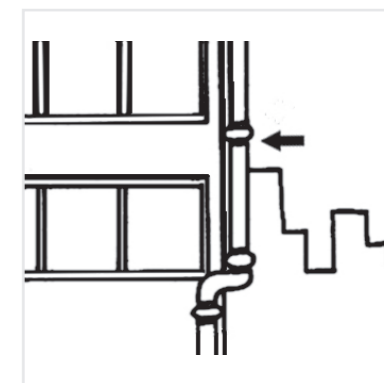
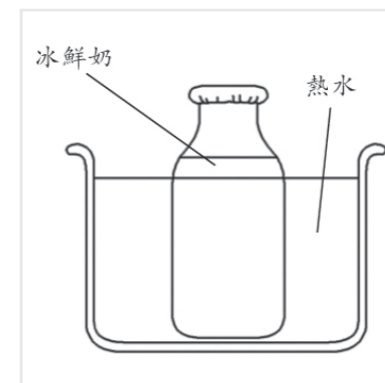
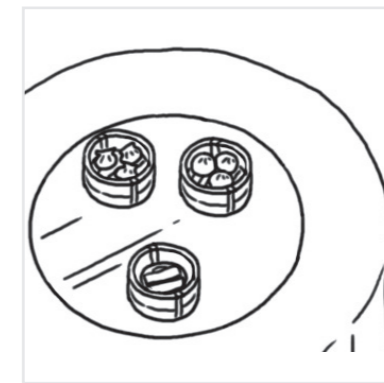
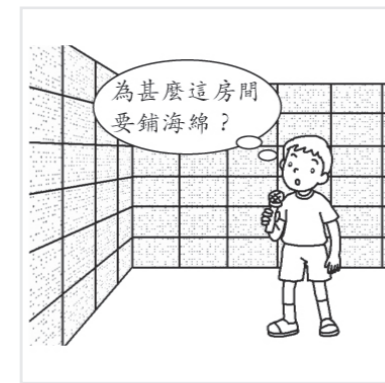
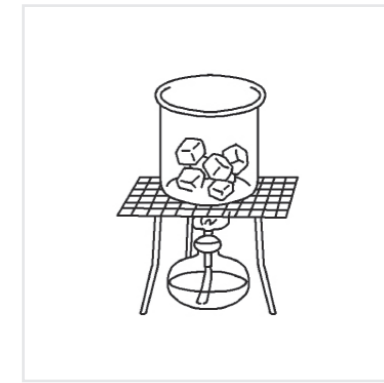
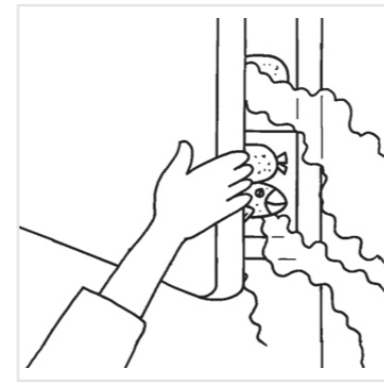



# 範疇三： 物質、能量和變化

## 物質的特性和變化

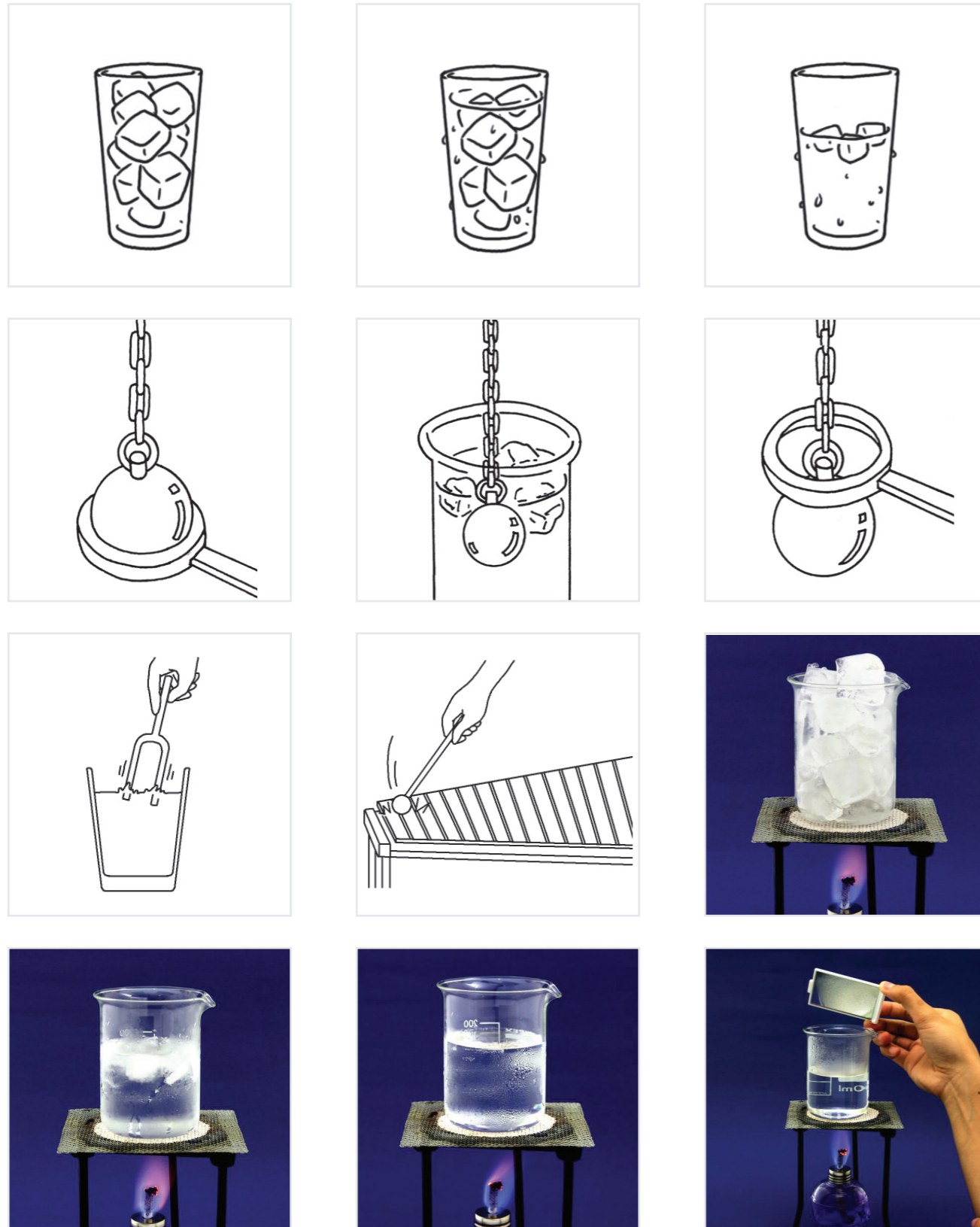

## 能量的不同形式和傳遞





# 範疇三： 物質、能量和變化

## 能量的不同形式和傳遞

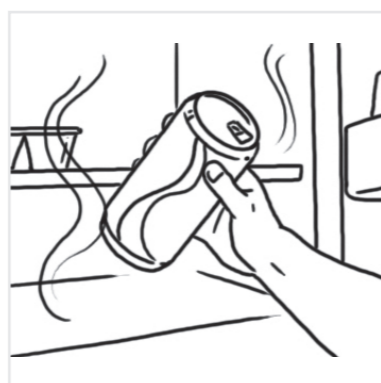
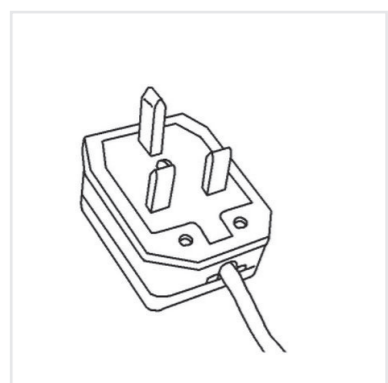
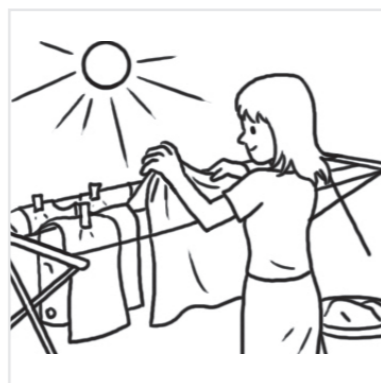
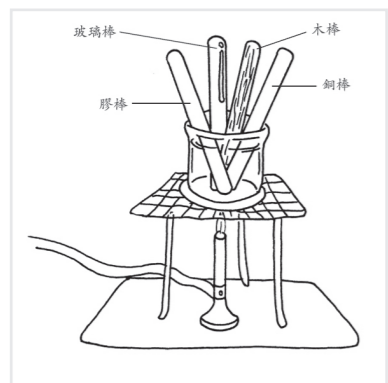
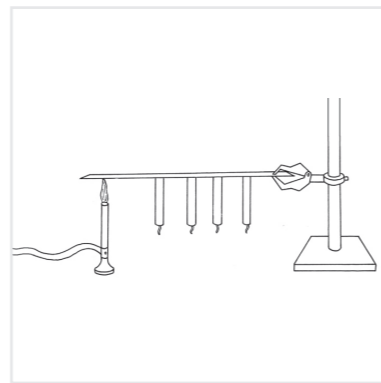
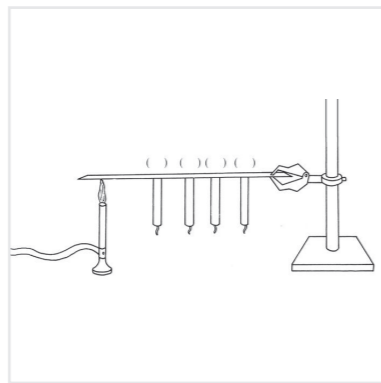

## 能量的不同形式和傳遞

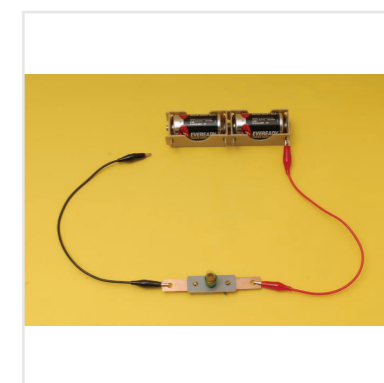
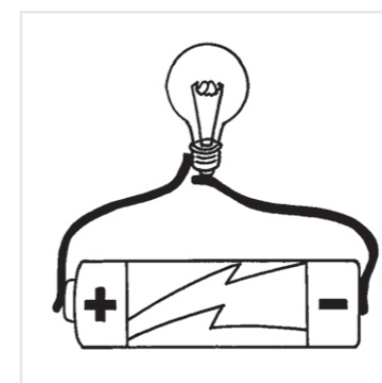
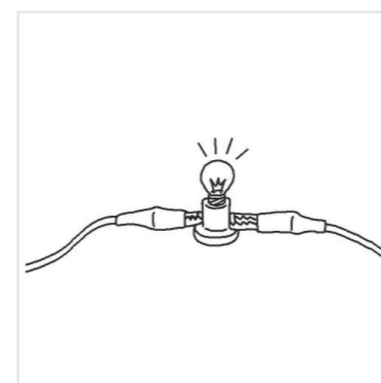
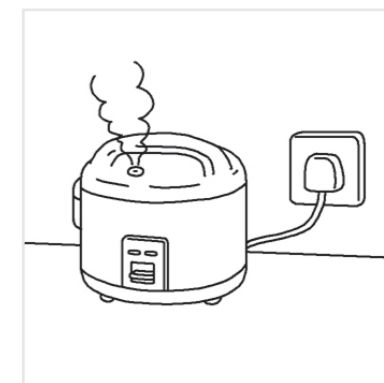
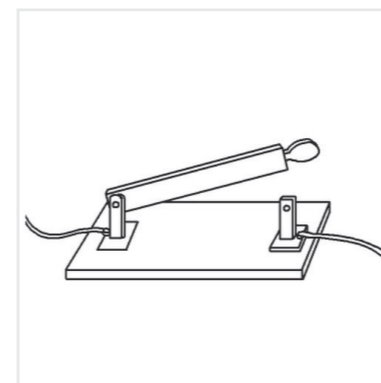
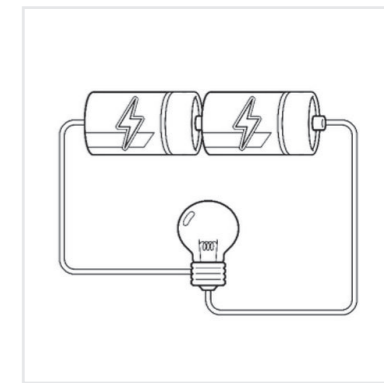
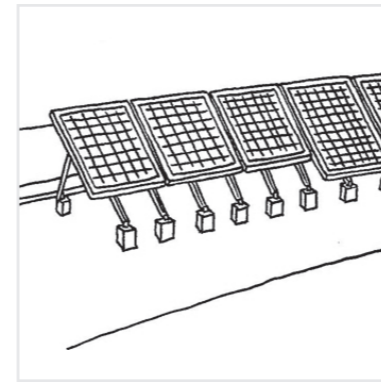



# 範疇三： 物質、能量和變化

## 力和運動

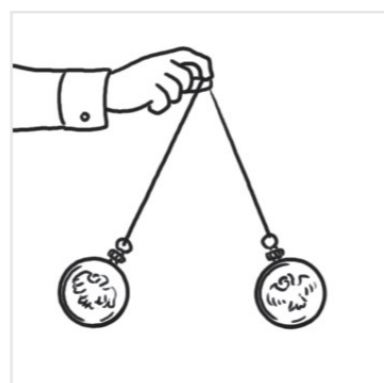
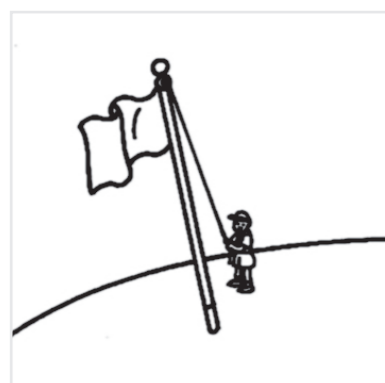
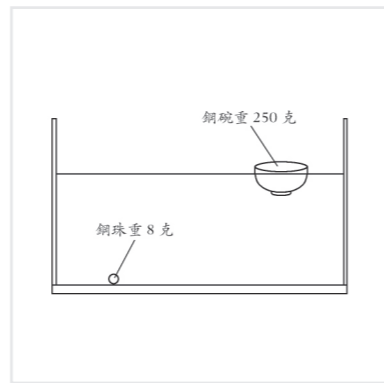
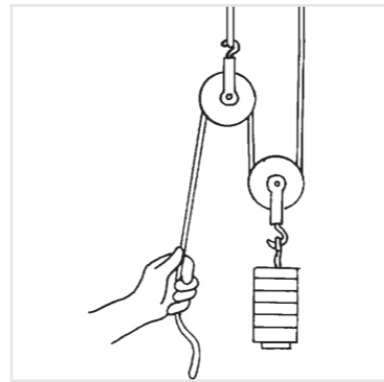
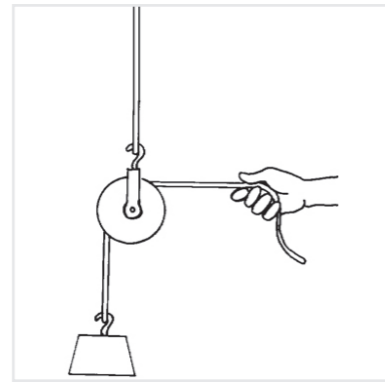
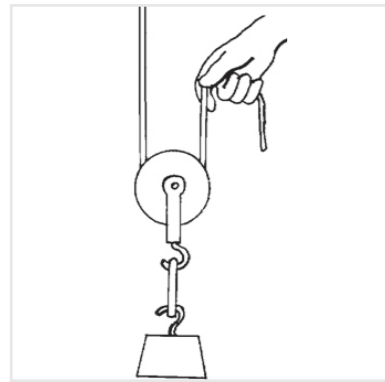

## 力和運動

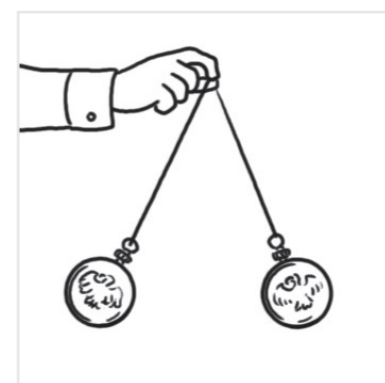
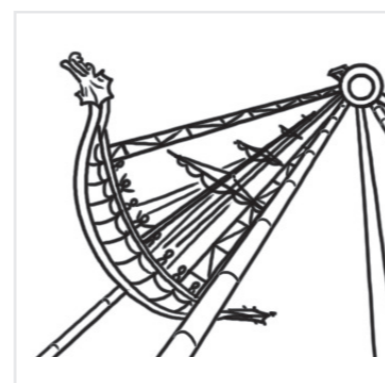
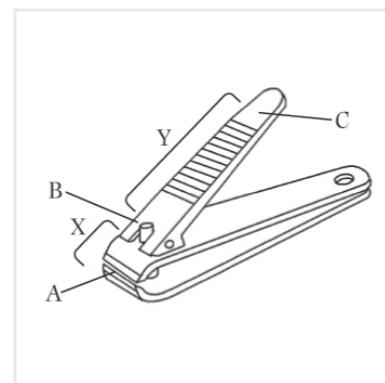
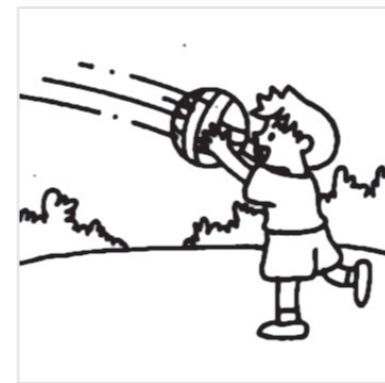
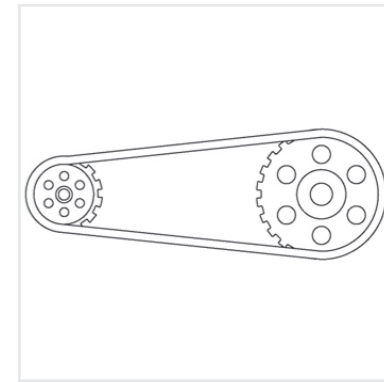
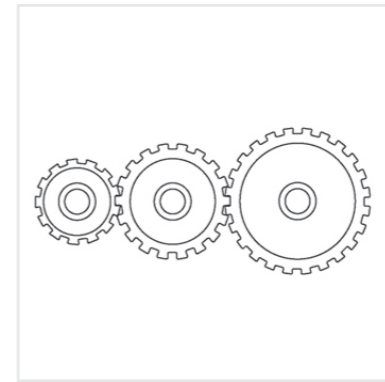
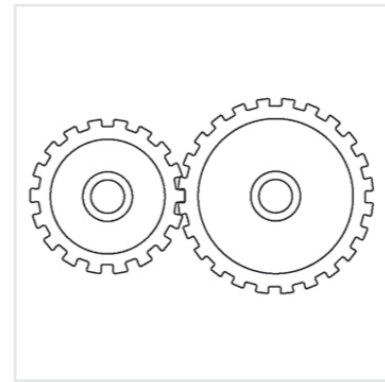



# 範疇三： 物質、能量和變化

## 力和運動

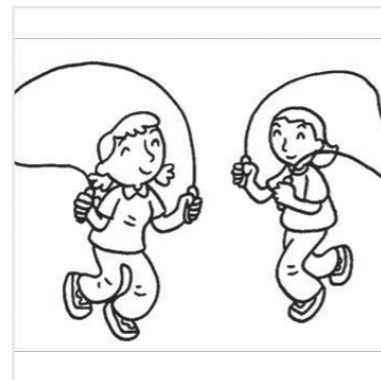
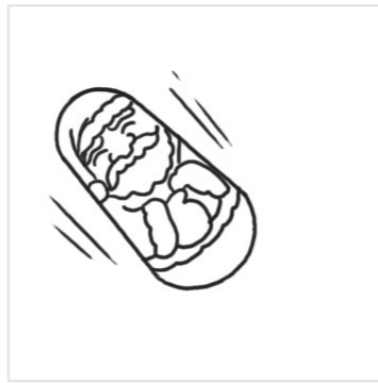
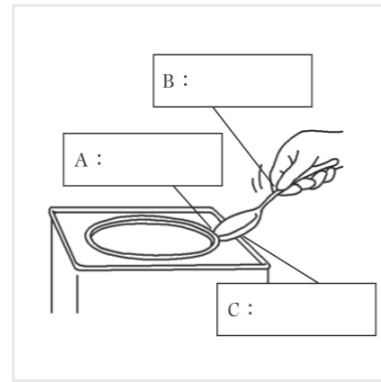
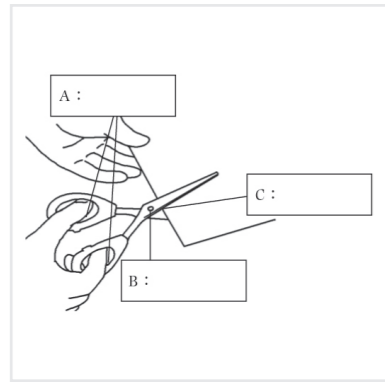

## 力和運動

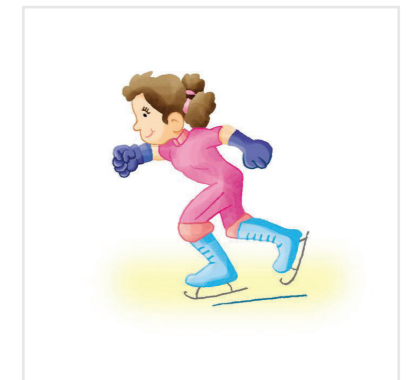
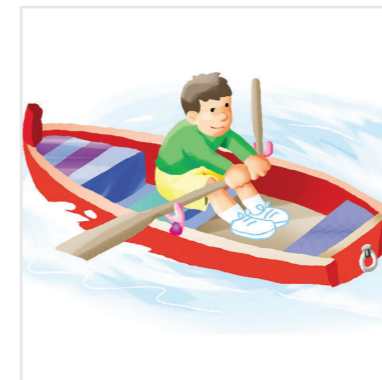
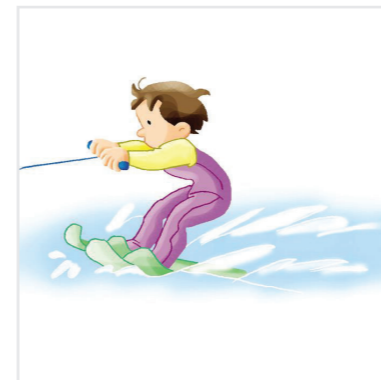
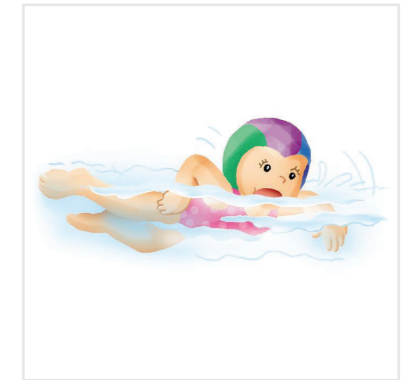
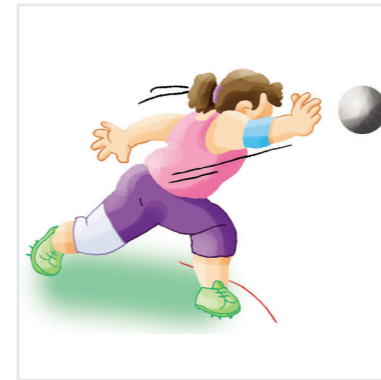
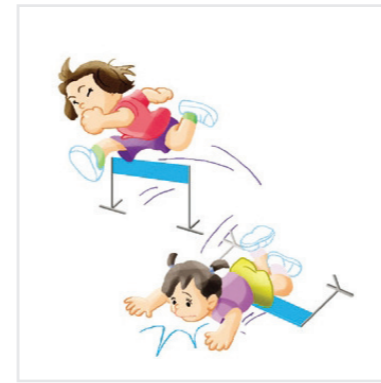



# 範疇四： 科學、科技、工程與社會

## 科學過程和科學精神

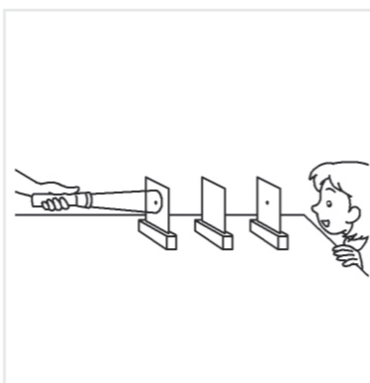
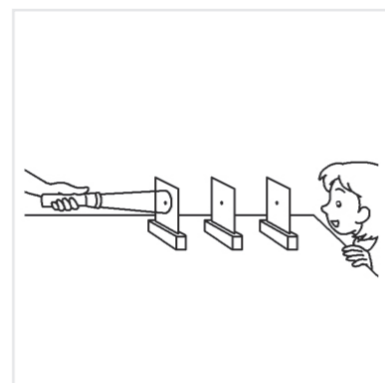
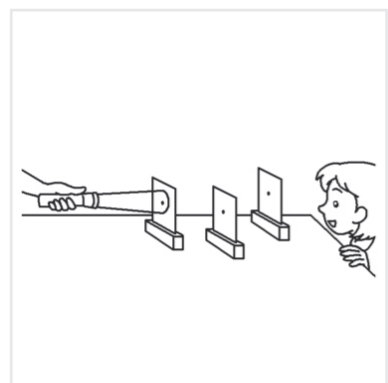
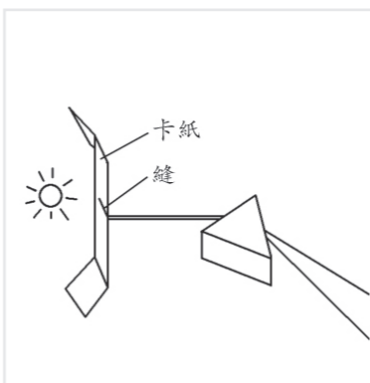
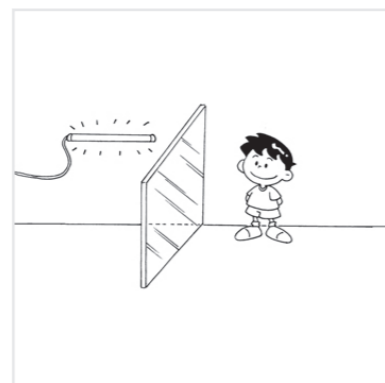
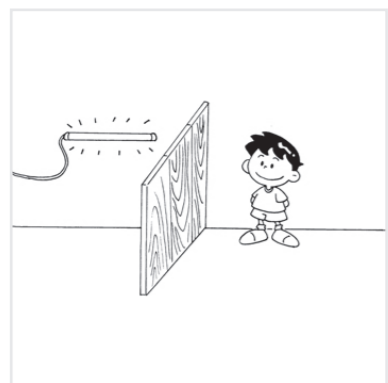
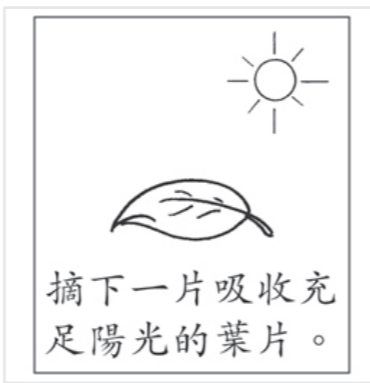
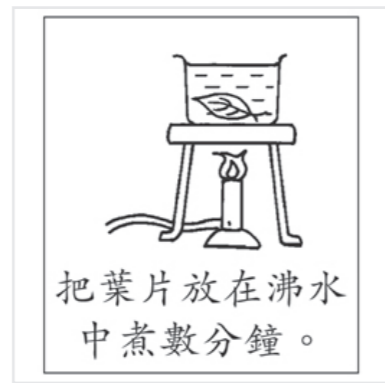
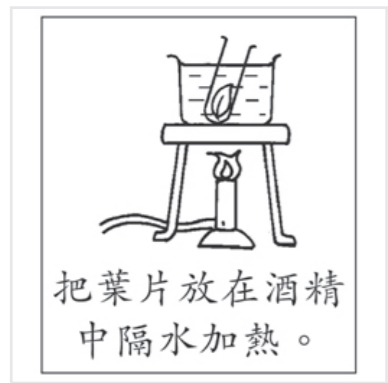
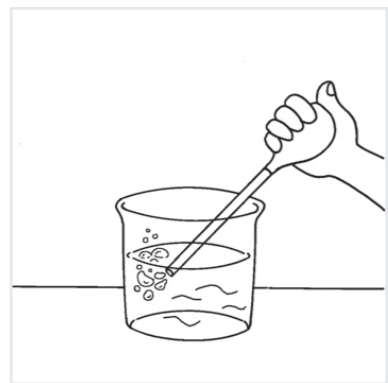

## 科學過程和科學精神

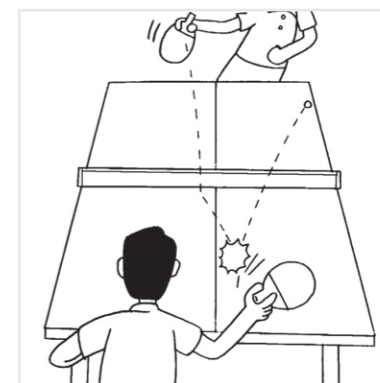
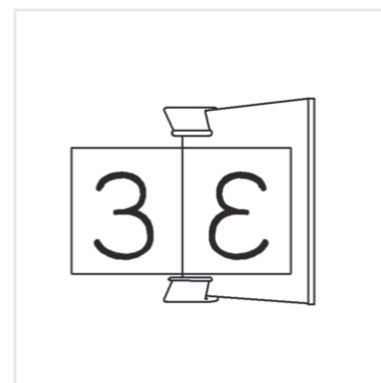
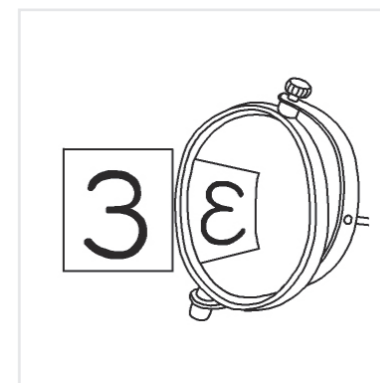
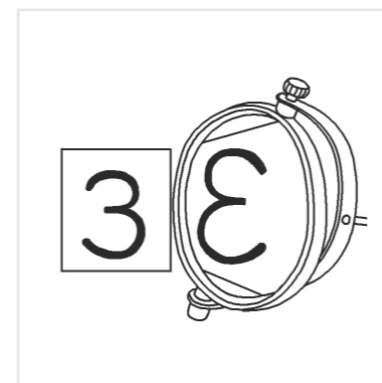
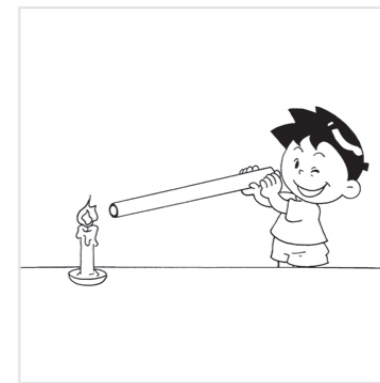
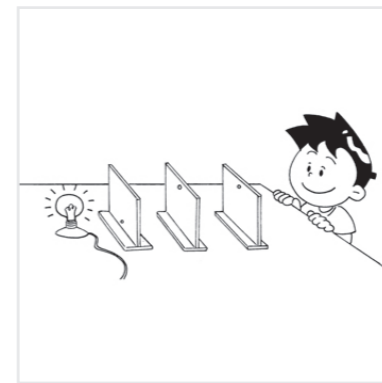
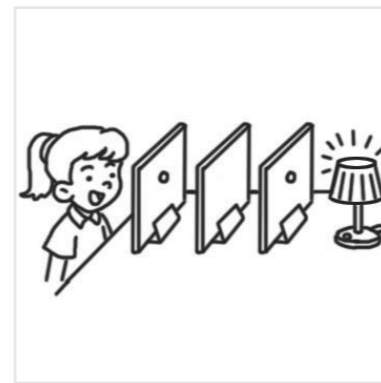
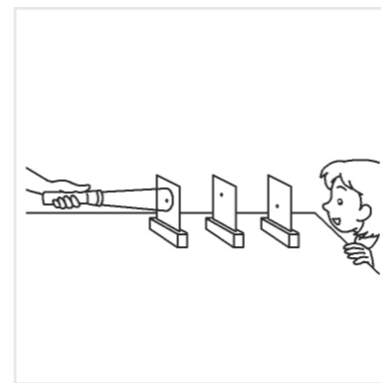



# 範疇四： 科學、科技、工程與社會

## 科學過程和科學精神

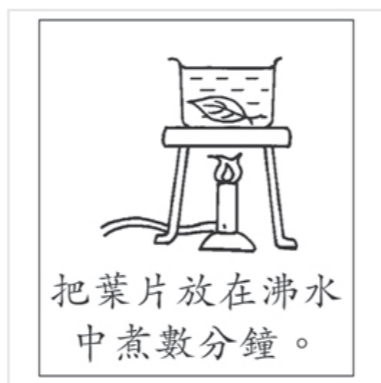
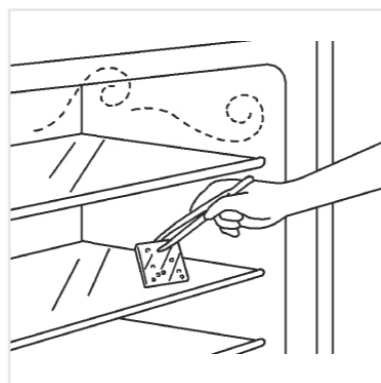
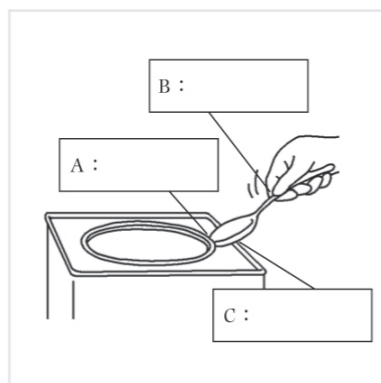
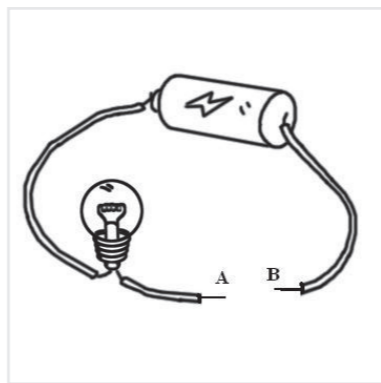
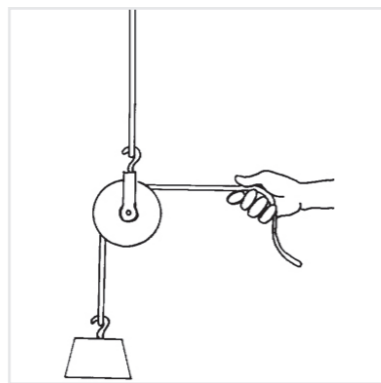
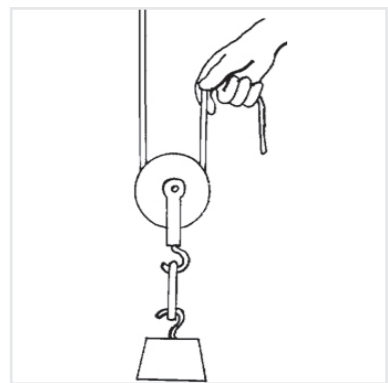

## 科學過程和科學精神

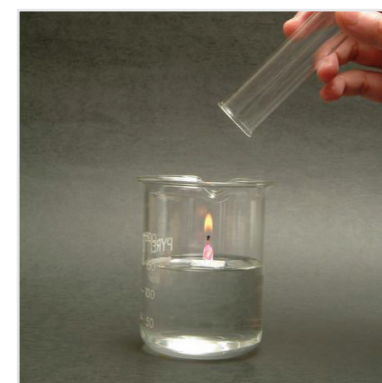
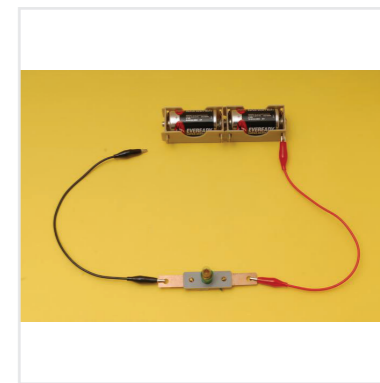



# 範疇四： 科學、科技、工程與社會

## 航天與創新科技

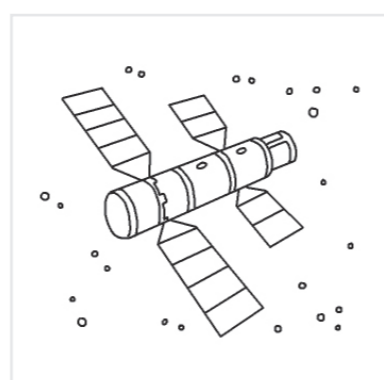
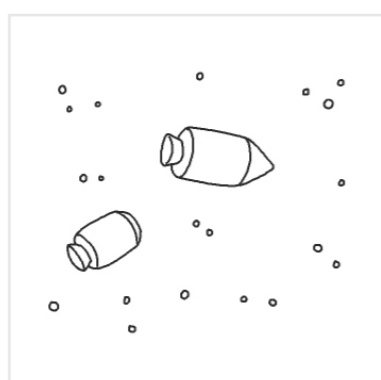
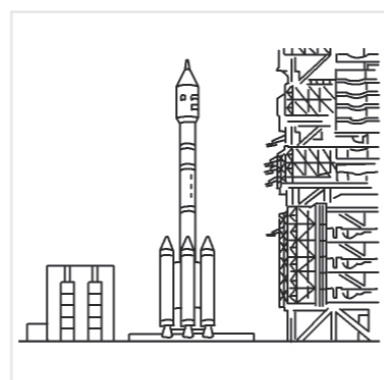
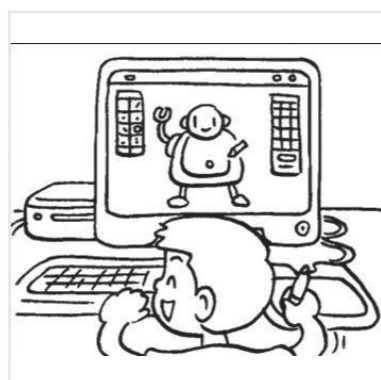
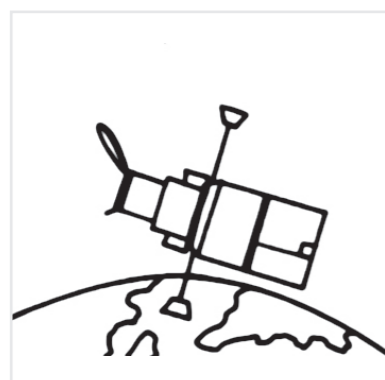
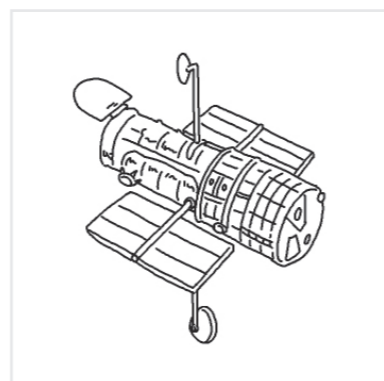
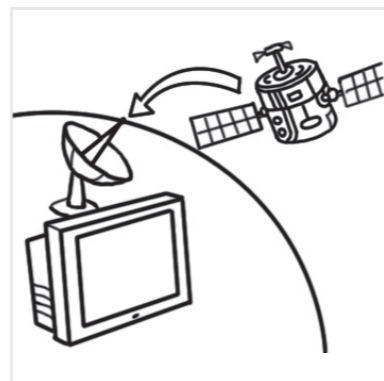
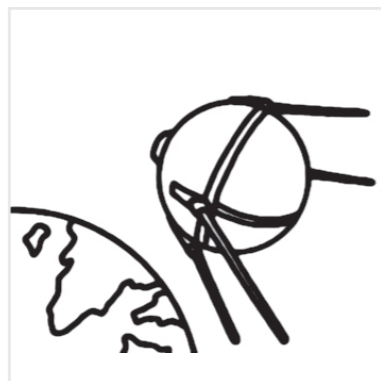

## 航天與創新科技

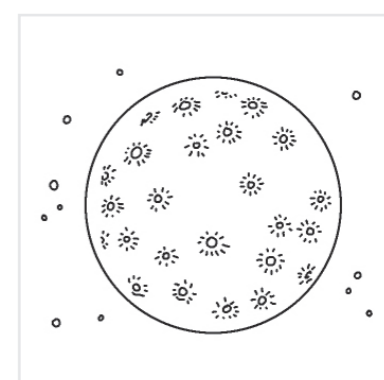
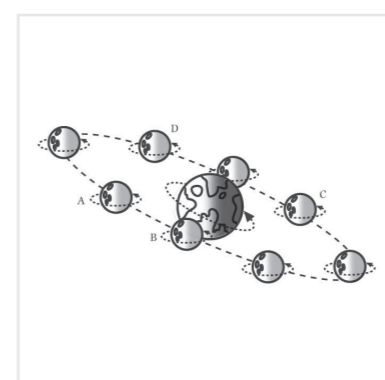
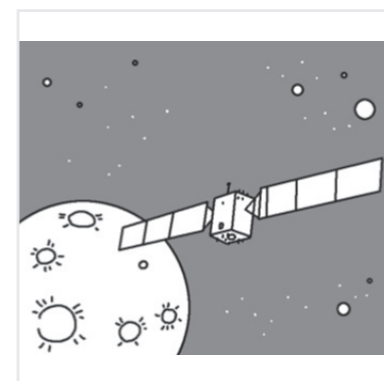
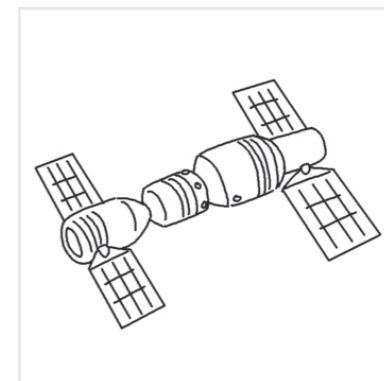





# 範疇四： 科學、科技、工程與社會

## 航天與創新科技

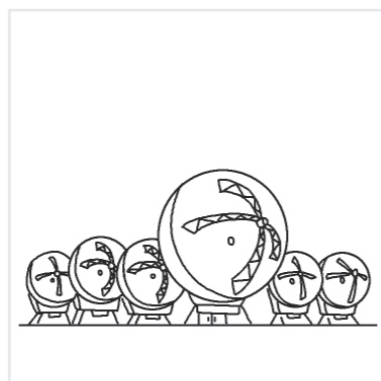
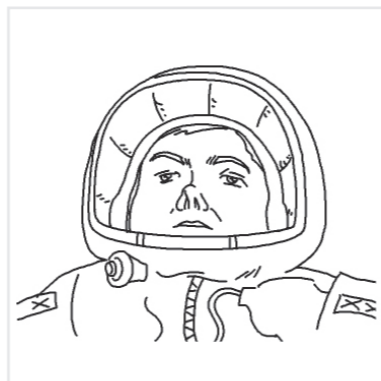
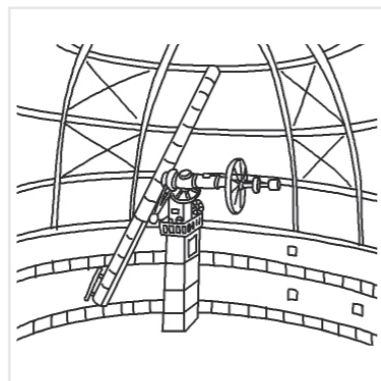
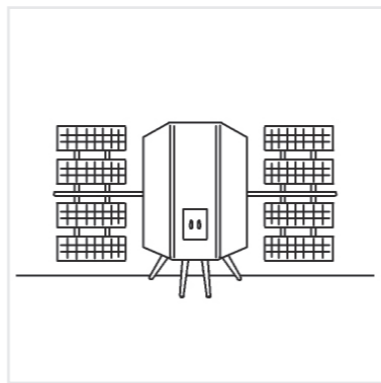
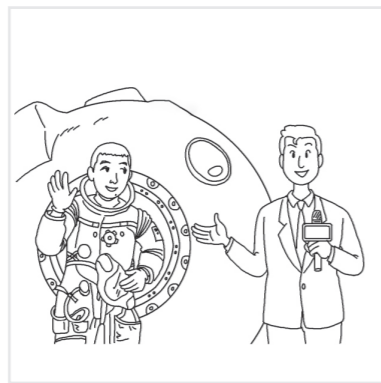
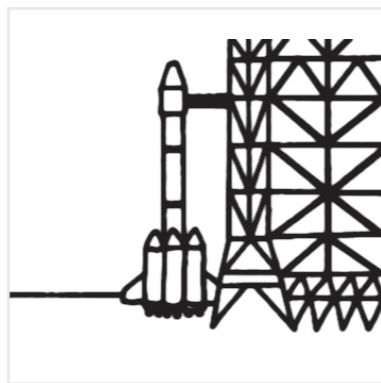

## 工程與設計

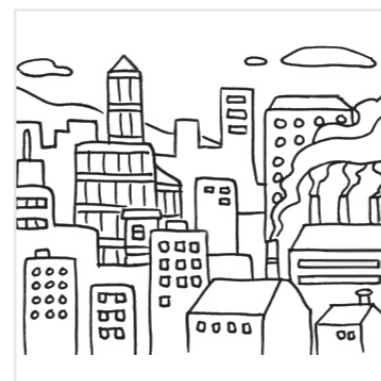
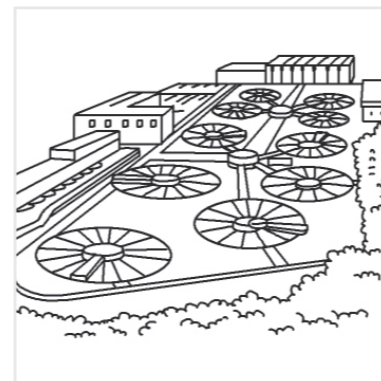



# 範疇四： 科學、科技、工程與社會

## 工程與設計

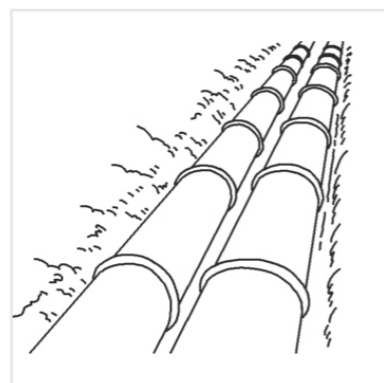
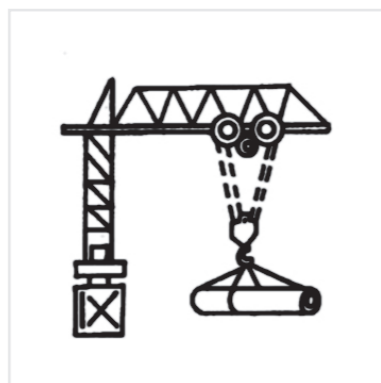
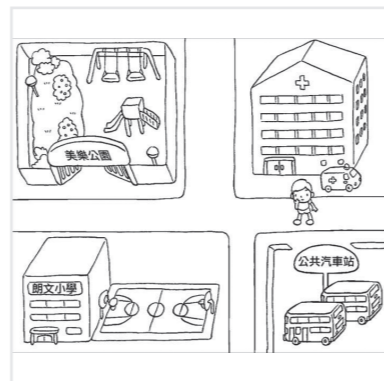
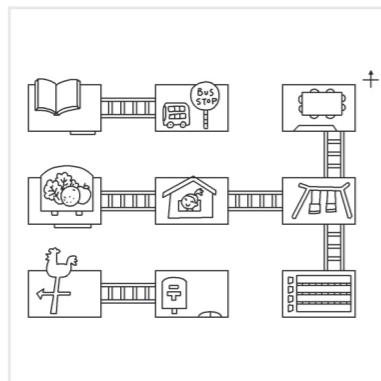
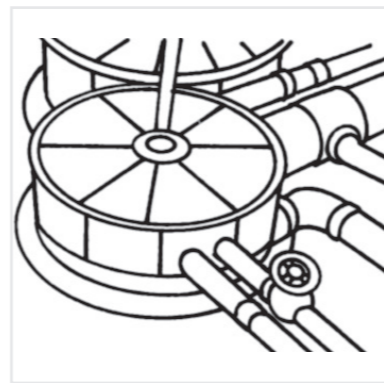
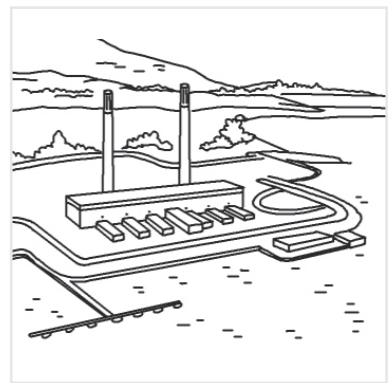
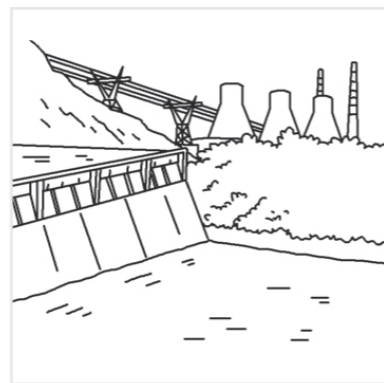

## 工程與設計

